



# IALA RECOMMENDATION (NORMATIVE)

## R0124 (A-124) APPENDIX 4 INTERACTION AND DATA FLOW MODEL OF THE AIS SERVICE

**Edition 1.1**

**December 2011**

**urn:mrn:iala:pub:r0124-4:ed1.1**



# DOCUMENT REVISION

---

Revisions to this document are to be noted in the table prior to the issue of a revised document.

Date	Details	Approval
December 2011	1 <sup>st</sup> issue	
September 2020	Ed. 1.1 Editorial corrections.	



# APPENDIX CONTENTS

---

<b>1</b>	<b>INTRODUCTION .....</b>	<b>6</b>
1.1	Index of Appendices to IALA Recommendation R0124 (A-124) on the AIS Service .....	6
1.2	Justification for the Interaction and Data Flow Model .....	7
1.3	Appendix Overview .....	7
1.4	Functional descriptions .....	7
<b>2</b>	<b>THE INTERACTION MODEL APPLIED TO THE AIS SERVICE .....</b>	<b>8</b>
2.1	Interaction and data flow within the AIS Service – an Overview .....	8
2.2	General identification of individual AIS components interactions .....	11
2.2.1	Interactions between AIS PSS Controlling Unit (AIS-PCU) and AIS fixed stations .....	11
2.2.2	Interactions between AIS PSS Controlling Unit (AIS-PCU) and AIS Logical Shore Stations (AIS-LSS)....	11
2.2.3	Interactions between AIS PSS Controlling Unit (AIS-PCU) and the AIS Service Management (ASM)...	12
2.2.4	Interactions between AIS Logical Shore Stations (AIS-LSS) and the AIS Service Management (ASM) .	13
2.2.5	Interaction between AIS-LSS and AIS-LSS .....	14
2.2.6	Resulting fundamental technical prerequisites .....	15
<b>3</b>	<b>INTERACTION AND DATA FLOW FOR THE EXTERNAL BAS .....</b>	<b>16</b>
3.1	Interaction and data flow for external BAS A_DYN, A_STAT, A_VOY, B_DAT, SAR_DAT, SART_DAT, STA_PROFILE .....	18
3.2	Interaction and data flow for external BAS ATON_DAT .....	20
3.3	Interaction and data flow for external BAS ASC_AD, SAFE_AD .....	22
3.4	Interaction and data flow for external BAS ASC_BR, SAFE_BR .....	27
3.5	Interaction and data flow for external BAS DGNS_COR .....	29
3.6	Interaction and data flow for external BAS INT_TDMA .....	31
3.7	Interaction and data flow for external BAS ASGN_RATE .....	34
3.8	Interaction and data flow for external BAS ASGN_GROUP .....	36
3.9	Interaction and data flow for external BAS AIS_MON .....	38
<b>4</b>	<b>INTERACTION AND DATA FLOW FOR THE INTERNAL BAS .....</b>	<b>40</b>
4.1	Interaction and data flow for internal BAS INIT_AIS, TERM_AIS, LSS_MGMT, PCU_MGMT, STA_MGMT .....	42
4.2	Interaction and data flow for internal BAS BASE_DAT .....	43
4.3	Interaction and data flow for internal BAS FATDMA and CH_MGMT .....	45
4.4	Interaction and data flow for internal BAS AIS_MON .....	47

## List of Tables

<i>Table 1</i>	<i>External BAS Services .....</i>	<i>18</i>
<i>Table 2</i>	<i>AtoN_DAT service description .....</i>	<i>20</i>
<i>Table 3</i>	<i>ACS_AD &amp; SAFE_AD service description .....</i>	<i>22</i>



# APPENDIX CONTENTS

---

Table 4	ASC_BR & SAFE_BR service description .....	27
Table 5	DGNS_COR service description .....	29
Table 6	INT_TDMA service description .....	31
Table 7	ASGN_RATE service description.....	34
Table 8	ASGN_GROUP service description .....	36
Table 9	AIS_MON service description .....	38
Table 10	Description of management & configuration services .....	42
Table 11	BASE_DAT description.....	43
Table 12	FATDMA & CH_MGMT service decription .....	45
Table 13	AIS_MON service decription.....	47

## List of Figures

Figure 1	Layered structure of AIS Service – Structure model of the AIS Service.....	9
Figure 2	Example of interactions within an AIS Service and with other shore-based services.....	10
Figure 3	Interactions between AIS-PCU and AIS-LSS .....	11
Figure 4	Interactions between AIS-PCU and ASM .....	12
Figure 5	Interactions between AIS-LSS and ASM.....	13
Figure 6	Interactions between AIS-LSS and AIS-LSS.....	14
Figure 7	Template for external BAS interaction & data flow model.....	17
Figure 8	Interaction & data flow model for external BAS A_DYN, A_STAT, A_VOY, B_DAT, SAR_DAT, SART_DAT, STA_PROFILE .....	19
Figure 9	Interaction & data flow model for external BAS ATON_DAT in Rx mode.....	21
Figure 10	Interaction & data flow model for external BAS ATON_DAT in Tx mode.....	22
Figure 11	Interaction & data flow model for external BAS ASC_AD, SAFE_AD in Rx mode when addressed to MMSI of fixed station.....	24
Figure 12	Interaction & data flow model for external BAS ASC_AD, SAFE_AD in Rx mode when addressed to MMSI of AIS client.....	25
Figure 13	Interaction & data flow model for external BAS ASC_AD, SAFE_AD in Tx mode.....	26
Figure 14	Interaction & data flow model for external BAS ASC_BR, SAFE_BR in Rx mode .....	28
Figure 15	Interaction & data flow model for external BAS ASC_BR, SAFE_BR in Tx mode .....	29
Figure 16	Interaction & data flow model for external BAS DGNS_COR.....	31
Figure 17	Interaction & data flow model for external BAS INT_TDMA .....	33
Figure 18	Interaction & data flow model for external BAS ASGN_RATE.....	35
Figure 19	Interaction & data flow model for external BAS ASGN_GROUP .....	37
Figure 20	Interaction & data flow model for external BAS AIS_MON .....	39



# APPENDIX CONTENTS

---

<i>Figure 21</i>	<i>Template for internal BAS interaction &amp; data flow model.....</i>	<i>41</i>
<i>Figure 22</i>	<i>Interaction &amp; data flow model for internal BAS INIT_AIS, TERM_AIS, LSS_MGMT, PCU_MGMT and STA_MGMT.....</i>	<i>43</i>
<i>Figure 23</i>	<i>Interaction &amp; data flow model for internal BAS BASE_DAT.....</i>	<i>44</i>
<i>Figure 24</i>	<i>Interaction &amp; data flow model for internal BAS FATDMA and CH_MGMT.....</i>	<i>46</i>
<i>Figure 25</i>	<i>Interaction &amp; data flow model for internal BAS AIS_MON.....</i>	<i>48</i>



# 1 INTRODUCTION

## 1.1 INDEX OF APPENDICES TO IALA RECOMMENDATION R0124 (A-124) ON THE AIS SERVICE

General:

Appendix 0 References, Glossary of terms and Abbreviations – to be developed

Deliverables of the AIS Service to the shore-based clients:

Appendix 1 Basic AIS Services, Data model & AIS Service specific MDEF sentences

Appendix 2 Intentionally blank

Architecture of the AIS Service:

Appendix 3 Distribution model – to be developed

Appendix 4 Interaction and data flow model

Appendix 5 Interfacing model

Appendix 6 Internal Time Latency model – to be developed

Appendix 7 Internal Reliability model – to be developed

Appendix 8 Test model – to be developed

Functional components of AIS Service:

Appendix 9 Functional description of the AIS Logical Shore Station – to be developed

Appendix 10 Functional description of the AIS PSS Controlling Unit – to be developed

Appendix 11 Functional description of the AIS Service Management – to be developed

Installation and life-cycle management issues of the AIS Service:

Appendix 12 Co-location issues at Physical Shore Stations (PSS) and on-site infrastructure considerations – to be developed

Appendix 13 Recommendation regarding efficient operation and maintenance – to be developed

Runtime configuration management of the VDL:

Appendix 14 FATDMA planning and operation

Appendix 15 Assigned mode operation – to be developed

Appendix 16 DGNSS broadcast via the AIS Service

Appendix 17 Channel management

Appendix 18 VDL loading management

Appendix 19 Satellite AIS considerations

## 1.2 JUSTIFICATION FOR THE INTERACTION AND DATA FLOW MODEL

---

This appendix first introduces the *interaction considerations* of the AIS Service, i.e. the **time-sequence dynamics** of the AIS Service. So far, mainly static aspects of the AIS Service have been considered in previous appendices. Sophistication in this regard arises from the **geographical distribution of the functional components** of the AIS Service (refer to the Distribution Model in appendix 3).

While the interaction considerations of the AIS components constitute sufficient justification for this appendix, it is appropriate and efficient to **combine these interactions with data flow considerations**. After all, the functional components of the AIS Service are all data flow entities.

**The Interaction and Data Flow Model described in this appendix offer a viable solution for all the above considerations.** Also, the consequences of the integration of the AIS Service into a Common Shore-based System Architecture (CSSA) regarding the data flow are discussed.

To achieve the above goals, the external and internal use cases of the AIS Service need to be mapped to its functional components. By doing this and since there is no other place in this Recommendation where this is done, **this appendix eventually contains the only complete mapping of the service use cases to the functional components of the AIS Service:** This means that this appendix serves as:

- the prerequisite for further specifics regarding the dynamics of the AIS Service such as:
  - Interfacing (appendix 5);
  - Internal Time Latency (appendix 6);
  - Internal Reliability (appendix 7); and
  - Testing of the AIS Service as a whole (appendix 8).
- the backplane ('chassis') for all descriptions of the functional components of the AIS Service as such (refer to later Appendices 9 to 11).

## 1.3 APPENDIX OVERVIEW

---

The *flow of thought* of this appendix is as follows. After introducing the general interactions and data flow considerations required for both internal and external BAS, the individual interactions between AIS components are presented. The interaction and data flow considerations are then explained for each BAS, external then internal.

The influence of alternative location of the AIS-PCU functionality on the Interaction and Data Flow Model will also be discussed for each BAS.

From the above, it follows that this appendix *depends on the definitions and descriptions developed in the previous parts of this Recommendation*. Their bearing on the Interaction and the Data Flow Model will be indicated where appropriate.

## 1.4 FUNCTIONAL DESCRIPTIONS

---

It should be noted that the Interaction and Data Flow Model presented in this appendix is a *functional description*. Hence, the Interaction and Data Flow Model **does not impose any specific technical implementation**.

On the contrary, there are many technical means from the Information Technology (IT) domain to achieve the desired functionality described herein. For example, the functionality can be implemented by using classical computing or by using a more networked approach to support the application level.

## 2 THE INTERACTION MODEL APPLIED TO THE AIS SERVICE

The Interaction Model has been introduced in the Main Body of this Recommendation. The various factors impacting the Interaction Model were also introduced; here they are merged in the Interaction Model.

### 2.1 INTERACTION AND DATA FLOW WITHIN THE AIS SERVICE – AN OVERVIEW

For discussion on the interaction of functional components and general data flow of the AIS Service, it is necessary to recognize the most important functional components. In the main document of this Recommendation, the following functional components of the AIS service were introduced:

- AIS Logical Shore Station (AIS-LSS);
- AIS PSS Controlling Unit (AIS-PCU);
- AIS Fixed Station;
- AIS Service Management (ASM).

Figure 1 is taken from the main body (Figure 4) of this recommendation and shows the relevant functional components for the Interaction Model. Of particular interest for the Interaction and Data Flow Model are the arrows depicted in Figure 1.

The bold arrows in Figure 1 represent the external BAS (Net Data) and the regular arrows represent the internal BAS (configuration and status). Hence, one can quickly see from Figure 1 what interactions are recommended and which ones are not. For example, the external BAS should respect the layered structure of the AIS and traverse the layers in order following the encapsulation principle. On the other hand, the internal BAS can be interfaced directly from the ASM to the AIS-PCU.



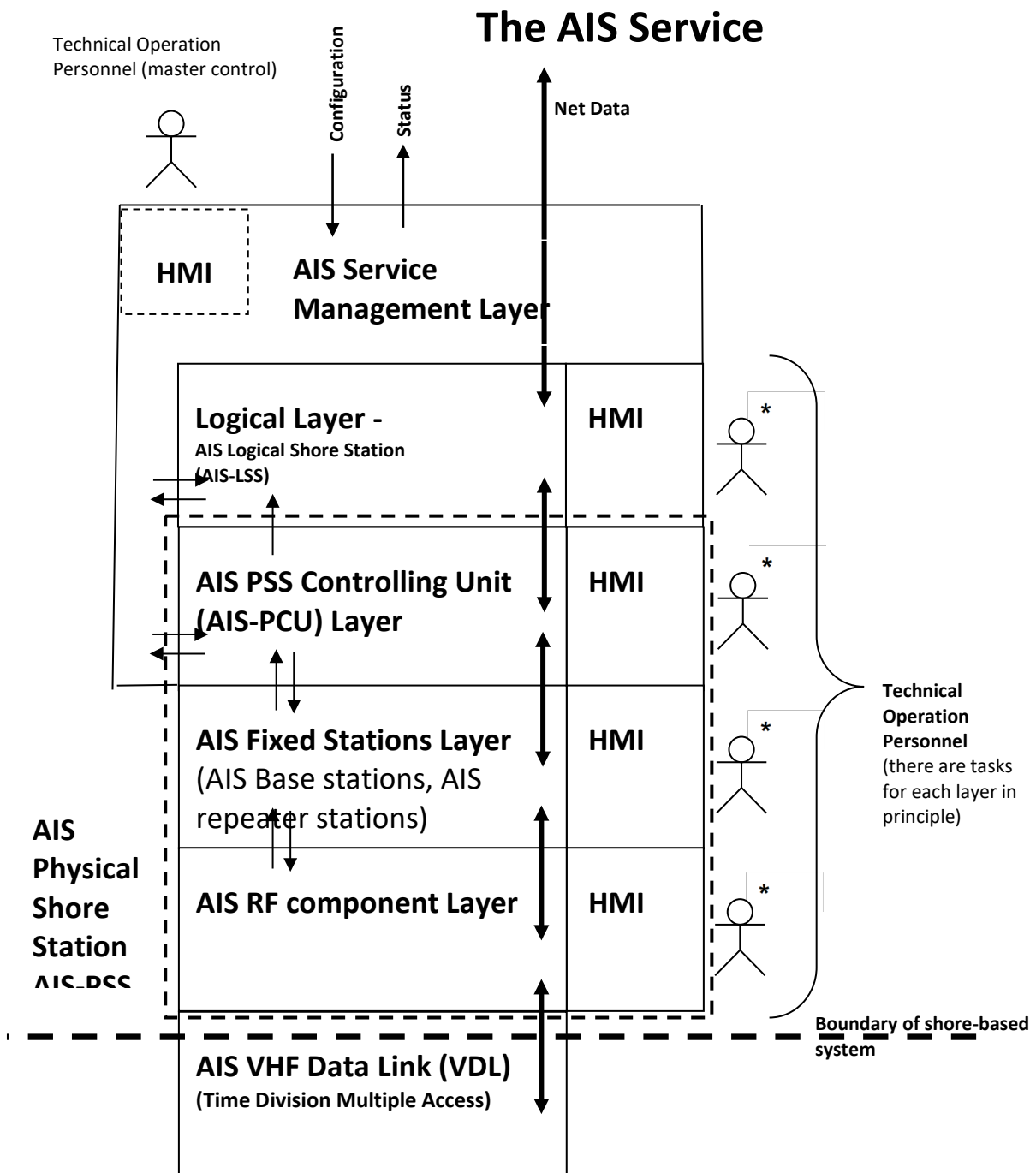

Figure 1 Layered structure of AIS Service – Structure model of the AIS Service

A functional description of the AIS-LSS, AIS-PCU and ASM is given in appendices 9, 10 and 11 respectively.

Figure 2 shows an example of an overview of the resulting interactions. It takes into account the requesting services of the shore-based technical systems, and also the supported end users.

It should be noted, that Figure 2 highlights the multiple interactions between instances of the above functional components. This reflects a practical situation since it is the instances of the functional components which actually materialize the desired functionality.

Figure 2 also gives an impression of the emerging *multitude of diverse functional links required*. This in turn requires a supporting physical network with a *large degree of connectivity*, i.e. the capability to connect flexible, seamlessly and cost efficiently to a large number of components, such as internet technology (Internet Protocol (IP)-based technology). In cases where it is not possible to achieve such a degree of connectivity, it is possible to interconnect AIS-LSS processes in order to accommodate different network topologies. This is discussed in section 2.2.5, *Interaction between AIS-LSS and AIS-LSS* below.

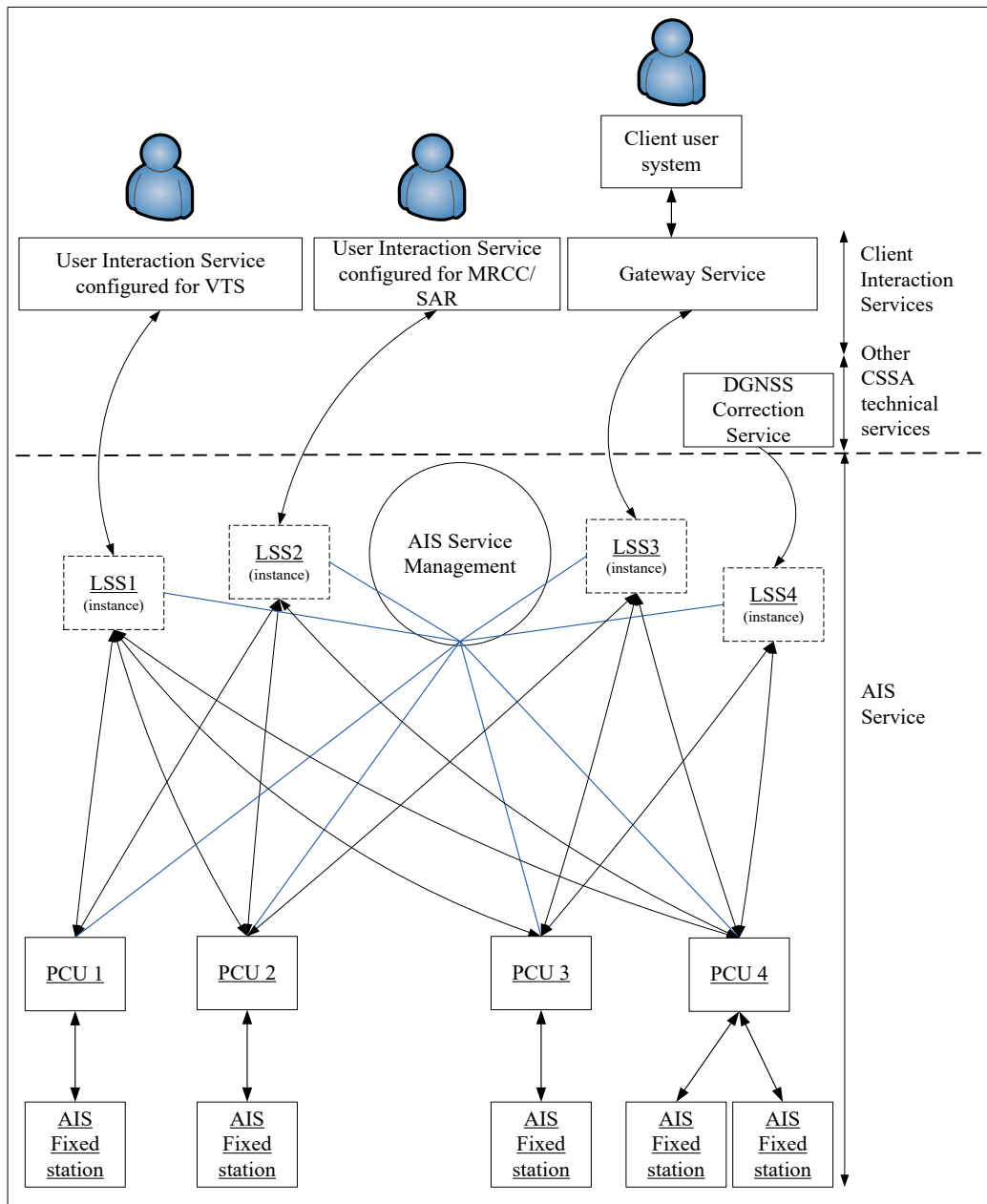

Figure 2 Example of interactions within an AIS Service and with other shore-based services

Note: Within this appendix a method is developed which simplifies the mesh of functional links. This mesh is shown as an example of the interactions which arise as soon as the functional components are instantiated.

## 2.2 GENERAL IDENTIFICATION OF INDIVIDUAL AIS COMPONENTS INTERACTIONS

This section describes the interactions within the AIS Service. MDEF sentences are referenced where appropriate, these are defined in appendix 1, the *Basic AIS Services, Data model & AIS Service specific MDEF sentences*. Regarding the encoding of the sentences identified below, please refer to the Interfacing Model of the AIS Service in appendix 5 for complete discussion.

### 2.2.1 Interactions between AIS PSS Controlling Unit (AIS-PCU) and AIS fixed stations

The interactions between the AIS-PCU and the AIS fixed stations is achieved by exchanging PI sentences. These sentences and their encoding are well defined in appropriate standards (e.g., IEC 62320-1, IEC 61162-1). The reader should refer to the appropriate standard for the type of AIS fixed station (base station, limited base station, repeater station, etc.) being interfaced as not all types of AIS fixed stations will be compatible with all PI sentences. For the remaining of this appendix, it will be assumed that an AIS fixed station compatible with the described BAS is used.

Depending on whether or not the AIS fixed station is used in dependant or independent mode, the PI sentences may be required to contain more or less data in order to make sure that the AIS fixed stations has the appropriate behaviour. This will be highlighted in the interaction and data flow description of each BAS.

It is important to mention that *PI sentences are one particular implementation of MDEF sentences* with a defined encoding. The rest of the interactions described in this section specify the use of MDEF sentences in a general way, which does not prevent PI sentences from being used to fulfil these interactions between AIS functional components. But PI sentences might not be the most appropriate way to realize these interactions and may limit the data exchange.

The AIS-PCU location can be co-located with the AIS fixed station or located in a different location. The location of the AIS-PCU has no effect on the interactions and data flow model presented in this document. But data flow considerations might have an impact on the location of the AIS-PCU. The data flow between the AIS-PCU and the AIS fixed stations must be reliable. It can also be relatively busy, hence require a greater amount of bandwidth. Because of the greater processing power available in the AIS-PCU, the AIS Service designer might choose to provide additional functionalities to compensate for other concerns such as limited bandwidth, unreliable network connection or even restrictive topology.

### 2.2.2 Interactions between AIS PSS Controlling Unit (AIS-PCU) and AIS Logical Shore Stations (AIS-LSS)

The interactions between the AIS-PCU and the AIS-LSS are done by exchanging AIS data using the AIS MDEF sentences.

The following statements describe the interactions between the AIS-PCU and the AIS-LSS. They are also represented in Figure 3.

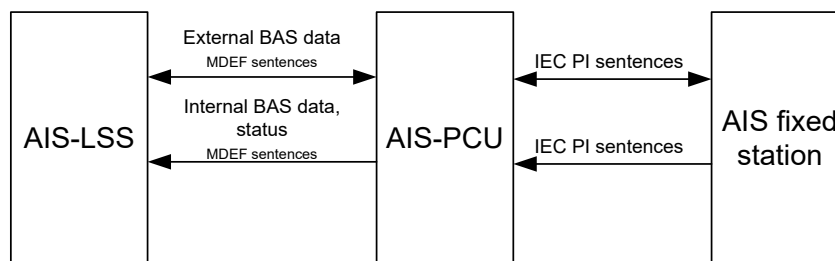

Figure 3 Interactions between AIS-PCU and AIS-LSS

#### 1 External BAS interaction

The first interaction between the AIS-PCU and the AIS-LSS is bi-directional and required by the External BAS. The AIS-PCU receives PI sentences related to the External BAS, processes them and sends the contents of

these messages to the AIS-LSS as AIS MDEF sentences. It also receives AIS MDEF sentences related to External BAS from the AIS-LSS, processes them and forwards them to AIS fixed stations as PI sentences. An example of this interaction is the processing of AIS Safety Related Messages.

Hence, the interactions pertaining to the External BAS might:

- a require the AIS-PCU to send a PI sentence to an AIS fixed station to transmit an AIS VDL messages on the VDL;
- b be triggered by the reception of a PI sentence from an AIS fixed station regarding an AIS VDL messages from the VDL.

Another example is the reception of a ship dynamic position report (VDL message 1) which would trigger an interaction between the AIS-PCU and the AIS-LSS where the AIS-PCU would send the received VDL information from the AIS fixed station to the AIS-LSS using MDEF sentences.

## 2 Status related internal BAS interaction

The second interaction between the AIS-PSS and the AIS-LSS is only from the AIS-PCU to the AIS-LSS. As first depicted in Figure 1, only status information related to Internal BAS is sent from the AIS-PCU to the LSS for:

- Data flow considerations based on failover scenarios or alternate path to destination;
- routing to appropriate clients of the AIS Service connected to that AIS-LSS.

The status information can be from the VDL, the AIS-PCU itself or from a connected AIS fixed station as shown in Figure 3 above. An example of this status information by the AIS-LSS would be a client trying to send an addressed safety message to a particular ship. In this case, the LSS needs to know about potential failures of the AIS-PCU or AIS fixed stations so that the LSS can route the message to a different AIS-PCU covering the same zone. In case no path to the addressed ship is available, the AIS-LSS could inform the client of the failure of the message. Hence the status information interaction between the AIS-PCU and the AIS-LSS is for internal real-time data flow concerns that might affect internal or external BAS.

Configuration information related to the Internal BAS is typically received from the ASM and described in section 2.2.3 and *should not originate from the AIS-LSS itself*. This does not prevent a client of the AIS service of sending configuration information routed through the AIS-LSS. But it is recommended that all configuration information sent to the AIS-PCU are first sent to the ASM in order to verify the appropriate privileges and assure that configuration priorities are respected between different configuration commands coming from different sources. *The AIS-LSS process itself should not send configuration information to the AIS-PCU.*

All these interactions use AIS MDEF sentences, but in this case, they would contain information regarding the monitoring of the VDL, the AIS fixed station or the AIS-PCU itself.

### 2.2.3 Interactions between AIS PSS Controlling Unit (AIS-PCU) and the AIS Service Management (ASM)

The interactions between the AIS-PCU and the ASM are done by exchanging AIS data using the AIS MDEF sentences.

The following statements describe the interactions between the AIS-PCU and the ASM. They are also represented in Figure 4.

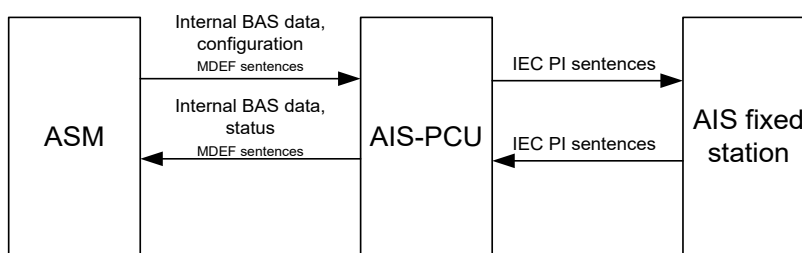

Figure 4 Interactions between AIS-PCU and ASM

## 1 Configuration related internal BAS interaction

The first interaction between the AIS-PCU and the ASM is only from the ASM to the AIS-PCU. Configuration information related to the Internal BAS is received from the ASM and forwarded as required to the AIS fixed station using PI sentences. An example of this is the configuration of the power setting of the AIS fixed station.

The interaction uses AIS MDEF sentences, but in this case, they would contain information regarding the configuration of the VDL, the AIS fixed station or the AIS-PCU itself.

## 2 Status related internal BAS interaction

The second interaction between the AIS-PCU and the ASM is only from the AIS-PCU to the ASM. The status information relayed to the ASM can be from the AIS-PCU itself or from a connected AIS fixed station as shown in Figure 3.

The interaction also uses AIS MDEF sentences, but in this case, they would contain information regarding the monitoring of the VDL, the AIS fixed station or the AIS-PCU itself.

In addition, there may also be some technical operation/management of the AIS-PCU from the ASM which are not executed via sentences (for example remote desktop, re-boot of servers, temperature control, etc.).

It is also important to mention that although not depicted in Figure 4, there might also be direct interaction between the ASM and the AIS-PCU regarding external BAS information in order for the ASM to provide additional features. It is left to the designer of the AIS system to choose to implement additional features requiring external BAS information to be sent directly to the ASM. It is important that the external BAS data flow does not have to go through the ASM to provide the external BAS to the clients in order to maintain the AIS Service in case of failure of the ASM.

### 2.2.4 Interactions between AIS Logical Shore Stations (AIS-LSS) and the AIS Service Management (ASM)

The interactions between the AIS-LSS and the ASM are done by exchanging AIS data using the AIS MDEF sentences.

The following statements describe the interactions between the AIS-LSS and the ASM. They are also represented in Figure 5.

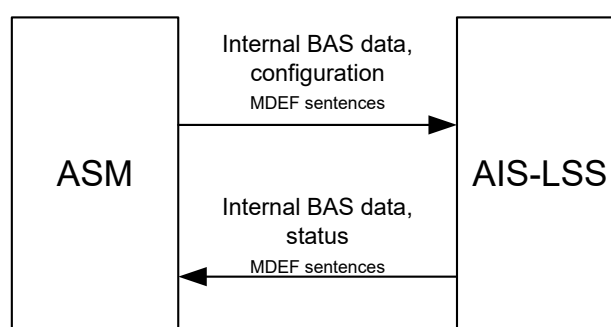

Figure 5 Interactions between AIS-LSS and ASM

## 1 Configuration related internal BAS interaction

The first interaction between the AIS-LSS and the ASM is only from the ASM to the AIS-LSS. Configuration information related to the AIS-LSS is received from the ASM. Actions initiated by the ASM, generally in response to input from the Technical Operation Personnel can be:

- Configuration of individual AIS-LSS instances;
- Management of individual AIS-LSS instances;
- Termination of individual AIS-LSS instances.

The interaction uses AIS MDEF sentences, but in this case, they would contain information regarding the configuration of the AIS-LSS and the BAS offered by this particular AIS-LSS.

## 2 Status related internal BAS interaction

The second interaction between the AIS-LSS and the ASM is only from the AIS-LSS to the ASM. The status data relayed to the ASM is from the AIS-LSS itself or from its connections to AIS-PCU or clients. Actions initiated automatically by the AIS-LSS instances:

- Sending of data and status from AIS-LSS instances to ASM;
- Sending of warning/alarm from AIS-LSS instances to ASM;

The interaction also uses AIS MDEF sentences, but in this case, they would contain data regarding the monitoring of the AIS-LSS itself and its connections.

In addition, there may also be some technical operation/management of the AIS-LSS from the ASM which are not executed via sentences (for example remote desktop, re-boot of servers, temperature control, etc.).

It is also important to mention that although not depicted in Figure 5, there might also be direct interaction between the ASM and the AIS-LSS regarding external BAS data in order for the ASM to provide additional features. It is left to the designer of the AIS system to choose to implement additional features requiring external BAS data to be sent directly to the ASM.

### 2.2.5 Interaction between AIS-LSS and AIS-LSS

As mentioned at the beginning of this section, AIS requires a high level of network connectivity (meshed network). The ideal level of connectivity might not always be possible in all topologies, hence it is required to allow for flexibility in the design and implementation of an AIS Service. In order to increase the available flexibility, interactions between AIS-LSSs are required. The AIS-LSSs become the building blocks that can be fitted to match any topology.

The interactions between an AIS-LSS and another AIS-LSS are done by exchanging AIS data using the AIS MDEF sentences. The following statements describe the interactions between the AIS-LSS and the ASM. They are also represented in Figure 6.

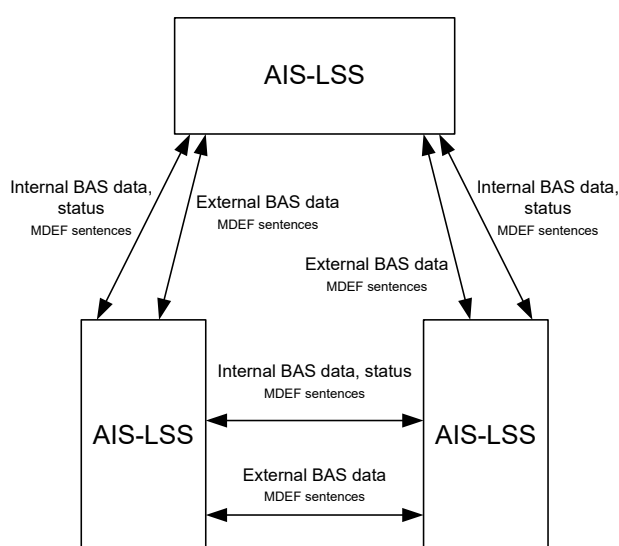

Figure 6 Interactions between AIS-LSS and AIS-LSS

## 1 External BAS interaction

The first interaction between the AIS-LSSs can be bi-directional or in a single direction depending on the topology. It relates to the External BAS. This interaction is required for some topologies to exchange data between AIS-LSSs. The interaction can occur between AIS-LSSs that have a hierarchical relationship, or between AIS-LSS that simply share data with each other. All data exchange between AIS-LSS uses MDEF sentences.

Different relationships can be defined between different AIS-LSSs. For example, a 'top-level' AIS-LSS can receive data from two different AIS-LSSs covering two different geographical areas. In another topology, the two AIS-LSSs covering different geographical zones might simply exchange data with each other.

Particular care must be taken when exchanging data from one AIS-LSS to another AIS-LSS especially when using bi-directional exchanges. It is important not to re-send the information to the connected AIS-LSS creating an infinite loop of data.

## 2 Status related internal BAS interaction

The second interaction between the AIS-LSSs can also be bi-directional or in a single direction depending on the topology. It relates to the Internal BAS and status monitoring. This interaction is required for some topologies to exchange status data between AIS-LSSs. The interaction can occur between AIS-LSSs that have a hierarchical relationship, or between AIS-LSS that simply share data with each other. All status data exchange between AIS-LSS uses MDEF sentences.

The status information can be from the VDL, an AIS-PCU, a connected AIS fixed station or the AIS-LSS itself. An example of this status information by the AIS-LSS would be a client trying to send an addressed safety message to a particular ship. In this case, the LSS needs to know about potential failures of all components in the chain so that the LSS can route the message to a different component covering the same zone. In case no path to the addressed ship is available, the AIS-LSS could inform the client of the failure of the message. Hence the status information interaction between the AIS-LSSs is for internal real-time data flow concerns that might affect internal or external BAS.

### 2.2.6 Resulting fundamental technical prerequisites

From the above considerations the following fundamental technical prerequisites can be deduced, which need to be fulfilled by proper planning (see the appropriate chapters and further Appendices):

- 1 Each of the layers of the AIS Service requires a certain **amount of processing capacity** to ensure proper and timely interactions of the components involved. The competent authority should provide the needed processing capacity.
- 2 The layered structure of the AIS Service does not expressively state transportation of data locally or over distances. **Between each layer a transportation process is required, which is called 'functional link'**. As introduced in the Distribution Model (appendix 3) there are the following functional links defined: LAN (local), WAN feeder link (remote), WAN backbone (remote). In the following chapters, the term '*remote*' indicates, that either a WAN feeder link or a WAN backbone functional link will be required. Whenever the term '*local*' appears, the LAN functional link would suffice.

The distances and capacity requirements of these functional links are totally dependent on local conditions. It is assumed, that the transportation processes, i.e. the functional links, do not constitute a bottleneck which determine the overall functionality. This can be achieved by standard modern technology even with high capacity needs or careful planning of the AIS Service topology.

- 3 Between each layer there are **functional interfaces**, which can be defined precisely. Regarding the encoding of the **sentences** identified above refer to Interfacing Model of the AIS Service in **appendix 5** for complete discussion.

### 3 INTERACTION AND DATA FLOW FOR THE EXTERNAL BAS

This chapter describes the interaction and data flow for the external BAS. It is essential for the reader of this section to be familiar with the drawing on the next page since it will be re-used to explain the interactions and data flow between AIS functional components for all external BAS. Of particular interest is the time axis at the top indicating the order of events for a particular BAS. The reader will also notice that different types of lines will be used to identify the interactions between the AIS-PCU and the dependant or independent types of AIS fixed stations. Careful interpretation of these lines is required since they represent recommended interactions and not the only possible interactions. For example, all independent AIS fixed stations should be compatible with the interactions described for a dependant fixed station. The inverse is not true.

It is also important to mention that some external BAS have been regrouped for simplicity since the interactions and data flow is identical for these external BAS.

In certain situations, it might be of interest to the AIS client to have access to metadata on the origin of the data such as from which AIS fixed station the VDL message was received or broadcasted. In order to fulfil this requirement, the unique identifier of the AIS fixed station can be appended to the VDM sentence using comment blocks as defined in IEC 62320-1. Other data such as a timestamp, reception time slot or transmission time slot can also be inserted in the comment blocks if required. The presence of such information should be detected by the AIS-PCU and forwarded accordingly in the MDEF sentences.

The AIS clients may also want to know from which AIS-PCU or AIS-LSS (in a hierarchical topology) the data originated from or was forwarded to. In those cases, the MDEF sentences should contain the appropriate fields to be forwarded to the AIS client.

It is interesting to mention that depending on whether the AIS Service has chosen to use independent or dependant mode AIS fixed stations, the AIS-PCU might need to provide more or less data for the PI sentences. For example, the dependant mode fixed stations will require to be told on which time slot to broadcast VDL messages. As such, the AIS-PCU should ensure that the selected transmission time slots have previously been reserved and that the desired transmission time slot is included in a TSA PI sentence associated with a VDM sentence.

It is also assumed in the following sections that the AIS-LSS will only process AIS data that it has been configured to process. The AIS-LSS, as configured by the ASM, must be able to restrict or allow access to all or any external BAS to its connected client(s). Finally, both the AIS-PCU and the AIS-LSS must be able to detect and remove duplicate messages that would've been received by more than one AIS fixed station.

*These considerations are valid for all external BAS and will not be repeated in the description of each BAS.*



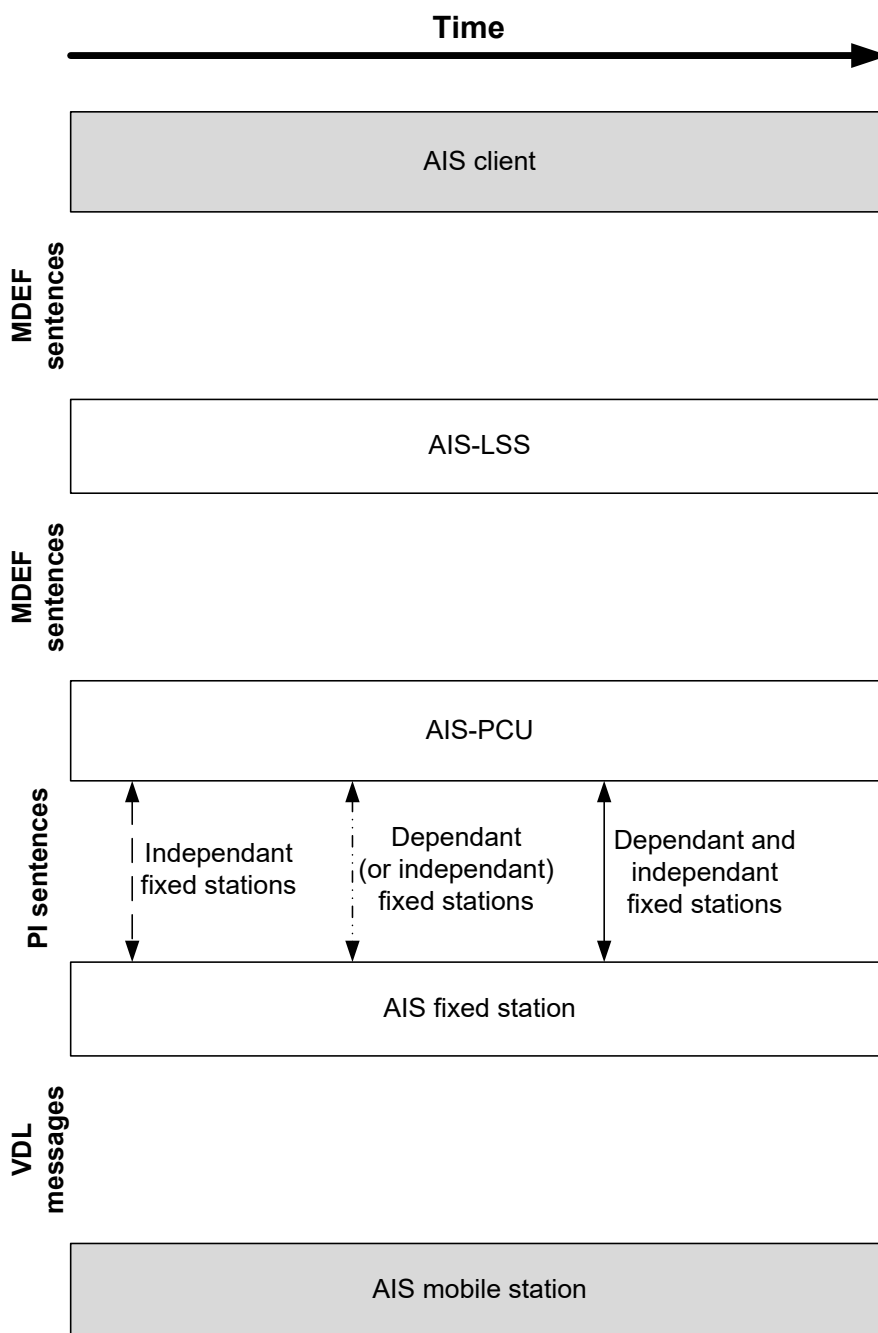

Figure 7 Template for external BAS interaction & data flow model

### 3.1 INTERACTION AND DATA FLOW FOR EXTERNAL BAS A\_DYN, A\_STAT, A\_VOY, B\_DAT, SAR\_DAT, SART\_DAT, STA\_PROFILE

The external BAS services in the following table have been regrouped since they are similar in the way they require the AIS Service functional components to interact and how the data flow is created. The interactions and data flow are triggered by the reception of the corresponding VDL messages by an AIS fixed station.

Table 1 External BAS Services

Service name	Tx/Rx	Description
A_DYN	Rx	Receive dynamic ship data from Class A shipborne mobile AIS stations
A_STAT	Rx	Receive static ship data from Class A shipborne mobile AIS stations
A_VOY	Rx	Receive voyage related ship data from Class A shipborne mobile AIS stations
B_DAT	Rx	Receive Ship data from Class B shipborne mobile AIS stations
SAR_DAT	Rx	Receive data from SAR airborne AIS stations
SART_DAT	Rx	Receive data from AIS-SART mobile AIS stations
STA_PROFILE	Rx	Monitoring of specific AIS stations external to the own AIS Service to provide status to AIS clients

The interaction and data flow model for the above external BAS is shown in Figure 8. These messages should be sent to all allowed AIS clients and are not acknowledged. There are no particular considerations for those external BAS other than the general considerations explained in the introduction of this section.

The external BAS STA\_PROFILE is a service that provides a way to monitor deployed AIS stations not connected to the AIS Service. In this case, the party interested in monitoring those stations, the competent authority operating the AIS Service or another competent entity, cannot use the external BAS AIS\_MON to fulfil the requirement. This service simply allows the interested party to receive the autonomous reports from the AIS station. It is technically no different that receiving the usual position reports from these stations, but for different operational reasons. In most cases, the interested party would only require to receive the reports from the particular monitored stations.

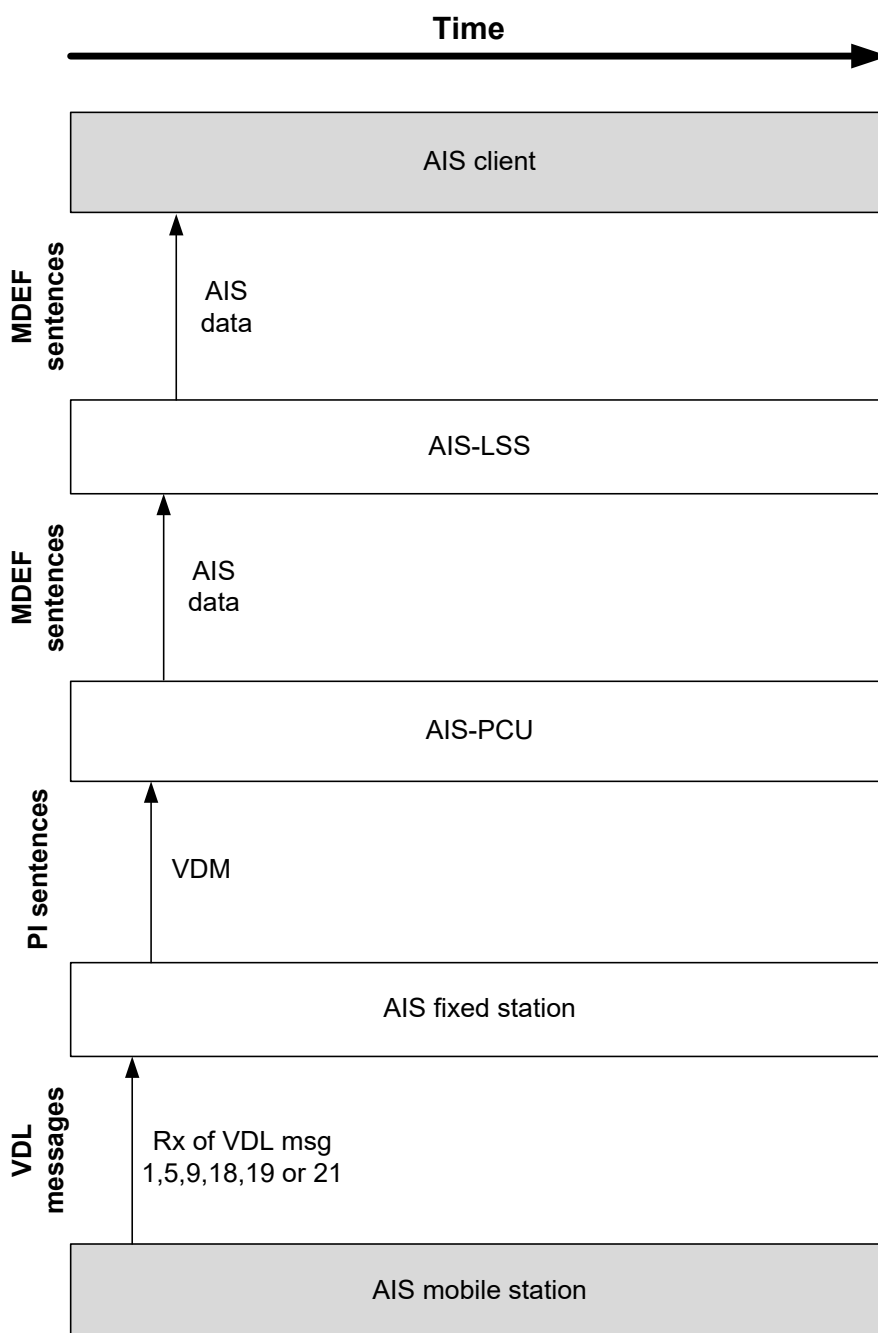

Figure 8 Interaction & data flow model for external BAS A\_DYN, A\_STAT, A\_VOY, B\_DAT, SAR\_DAT, SART\_DAT, STA\_PROFILE

## 3.2 INTERACTION AND DATA FLOW FOR EXTERNAL BAS ATON\_DAT

Table 2 AtoN DAT service description

Service name	Tx/Rx	Description
ATON_DAT	Tx & Rx	Send or receive AtoN AIS stations data

The ATON\_DAT external BAS can be used to monitor the status of an AtoN (Rx) or to broadcast the status of an AtoN (Tx). For more information on the use of AIS with regards to AtoN please refer to IALA recommendation A-126.

Figure 9 and 10 on the next pages show the interaction and data flow model for external BAS ATON\_DAT in reception and transmission, respectively.

The external BAS ATON\_DAT in reception mode is similar to the other external BAS presented so far and has no special considerations. It is triggered by the reception of a VDL message 21 by an AIS fixed station and should be sent to all allowed AIS clients.

The external BAS ATON\_DAT in transmission mode is triggered by the reception of AtoN data from an AIS client. The Tx AtoN data will usually be sent from an AIS client to its AIS-LSS but could also be sent from the ASM directly to the AIS-PCU if the ASM supports the management of AtoN.

It is important to consider the case where the Tx AtoN data needs to be transmitted by more than one AIS-PCU to cover the appropriate geographical region for this particular AtoN. In this case, the AIS-LSS will need to process the message accordingly and send the transmission request to different AIS-PCU, as well as expect multiple acknowledgements in return. This is represented by the 'x 1' and 'x n' in Figure 10 and explained in the paragraph below. The same concern is also valid in the case where there are more than one AIS fixed stations under the control of a single AIS-PCU. The AIS-PCU should create PI sentences for all concerned fixed stations and expect multiple broadcast confirmations in return.

The AIS-LSS will duplicate and route the Tx AtoN data to the appropriate AIS-PCU(s) to fully cover the desired geographical broadcast zone specified in the MDEF sentence from the AIS client. The AIS-PCU(s) will transform the MDEF sentence into a VDM PI sentence and forward it to the appropriate AIS fixed station(s). The AIS fixed station(s) will produce a VDO message to confirm that the VDL message 21 was indeed broadcasted.

The AIS-PCU(s) need to produce an acknowledgment that will be forwarded to the AIS-LSS. The AIS-LSS associated with the requesting AIS client must be able to gather all acknowledgements from the different broadcasting AIS-PCUs and verify that its client's request was fulfilled. A single acknowledgment per AIS Tx message containing the status of the transmission should be sent back to the client. The metadata considerations explained at the beginning of this section are especially important when sending the acknowledgment back to the client.

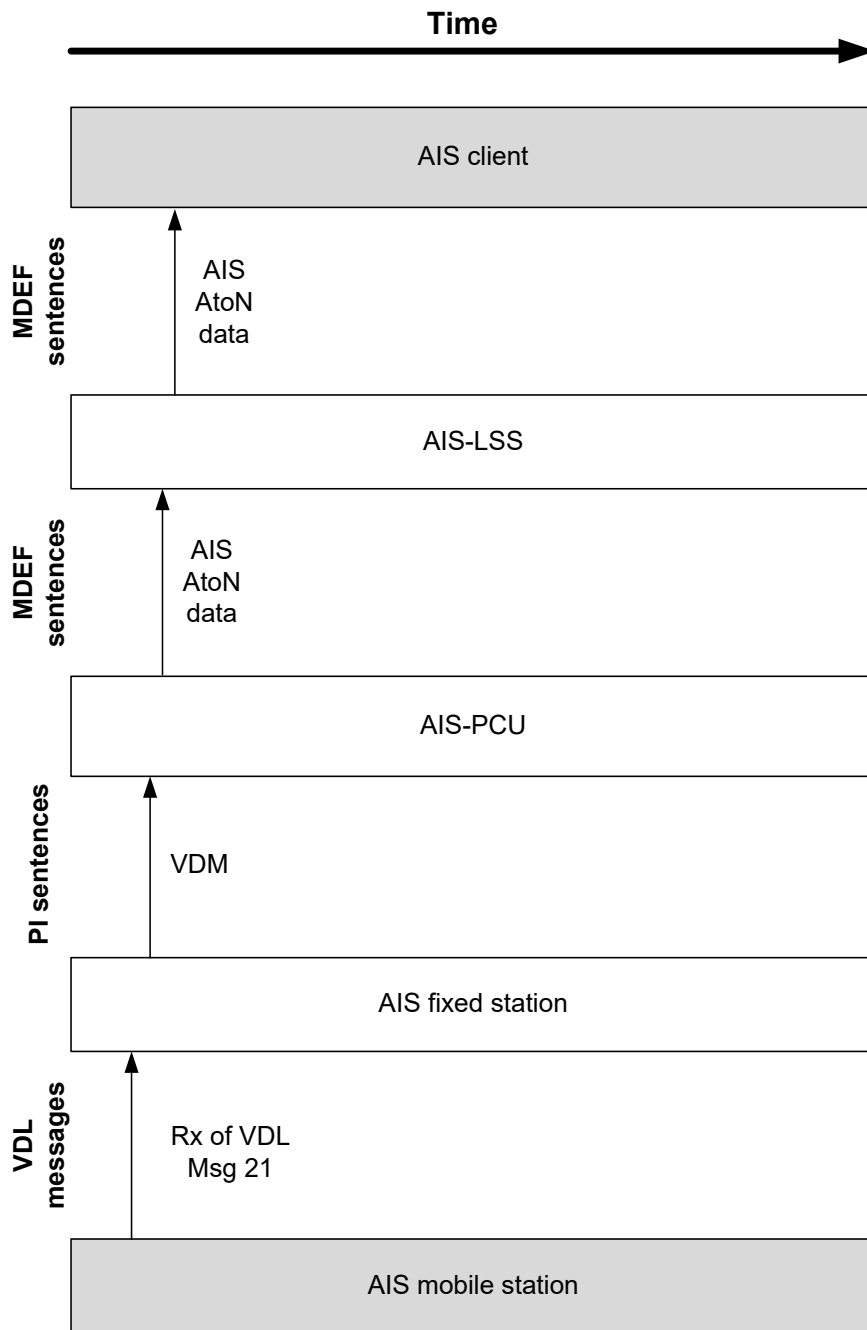

Figure 9 Interaction & data flow model for external BAS ATON\_DAT in Rx mode

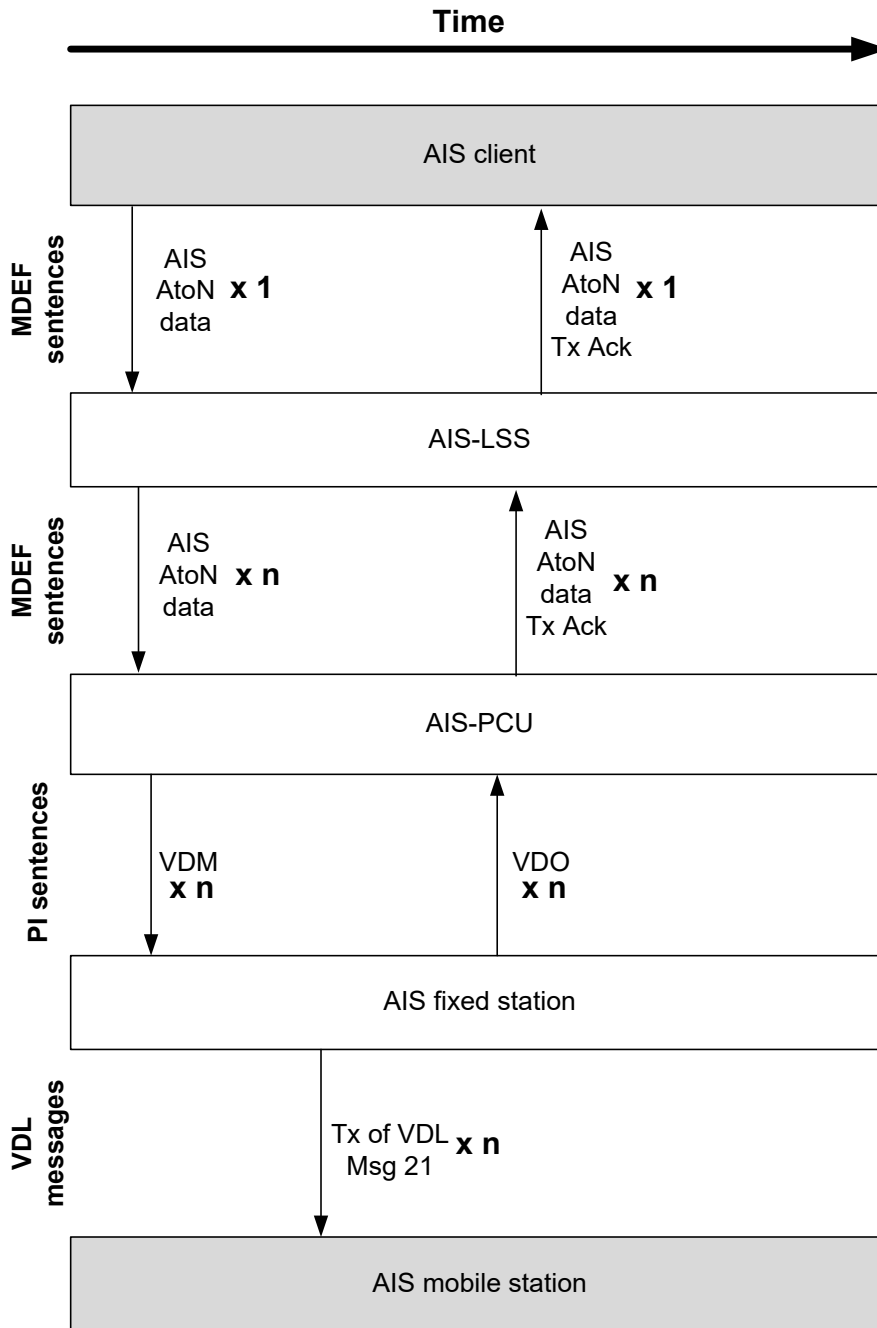

Figure 10 Interaction & data flow model for external BAS ATON\_DAT in Tx mode

### 3.3 INTERACTION AND DATA FLOW FOR EXTERNAL BAS ASC\_AD, SAFE\_AD

The external BAS services in the following table have been regrouped since they are similar in the way they require the AIS Service functional components to interact and how the data flow is created.

Table 3 ACS\_AD & SAFE\_AD service description

Service name	Tx/Rx	Description
ASC_AD	Tx & Rx	Addressed application specific messages
SAFE_AD	Tx & Rx	Safety related addressed message

With regards to external BAS ASC\_AD and SAFE\_AD, there are 2 cases that need to be considered in reception mode. These cases are if:

- 1 The received message is addressed to the MMSI of the AIS fixed station itself, or
- 2 It is addressed to the MMSI (virtual or real) of an AIS client.

Figure 11 and Figure 12 show the interaction and data flow model for external BAS ASC\_AD and SAFE\_AD in reception for those two cases respectively. Figure 13 shows the interaction and data flow model for external BAS ASC\_AD and SAFE\_AD in transmission mode.

The external BAS ASC\_AD and SAFE\_AD in reception mode are triggered by the reception of a VDL message 6 or 12 by an AIS fixed station. In scenario A, if the message is addressed to the MMSI of the AIS fixed station itself, an independent fixed station will immediately send a VDL message 7 or 13 to acknowledge the reception. A dependant station will wait to receive a VDM message from the AIS-PCU instructing it to send a VDL message 7 or 13 to acknowledge the reception of the original message.

In scenario B, the received message is addressed to the MMSI of an AIS client. In this scenario, the message should go up the chain of AIS components until it reaches the AIS-LSS for that particular client. The AIS-LSS instance connected to that AIS client should be the one sending the acknowledgment back to the AIS-PCU as soon as the message has been forwarded to its client. The AIS-PCU would then create a VDM PI sentence containing a VDL acknowledgment message (7 or 13) to be broadcasted by the AIS fixed station to the mobile.

The external BAS ASC\_AD and SAFE\_AD in transmission mode are triggered by the reception of an addressed message from an AIS client. The AIS-LSS will route the addressed message data to the most appropriate AIS-PCU for the location of the target. In turn, the AIS-PCU will route its PI sentences to the most appropriate AIS fixed station. If the AIS fixed station is an independent station, the AIS-PCU will send an ABM PI sentence to the fixed station who will autonomously manage the automatic retries (up to 4) and produce an ABK PI sentence to acknowledge the reception of VDL message 7 or 13, or signal the failure of the operation. The AIS-PCU should then forward the result of the operation to the AIS-LSS using MDEF sentences for it to advise its client.

If the AIS fixed station is a dependant station, the AIS-PCU will have to send VDM PI sentences to instruct the fixed station to broadcast a VDL message 6 or 12. The VDM sentence will have to be repeated up to 3 times (4 total) by the AIS-PCU if no acknowledgment is received from the mobile station. Depending on the result of the overall operation, the AIS-PCU will have to send an acknowledgment to the AIS-LSS to update its client.

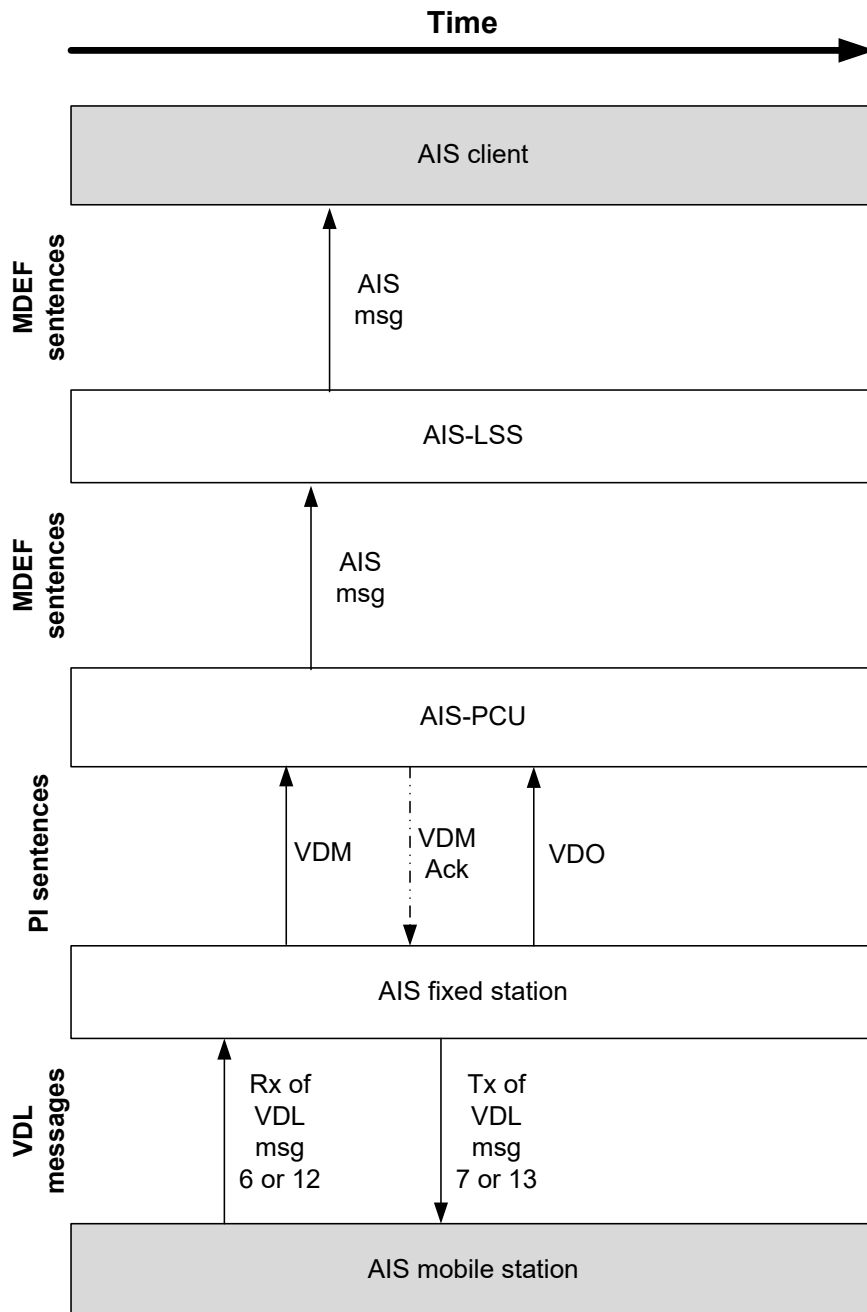

Figure 11 Interaction & data flow model for external BAS ASC\_AD, SAFE\_AD in Rx mode when addressed to MMSI of fixed station



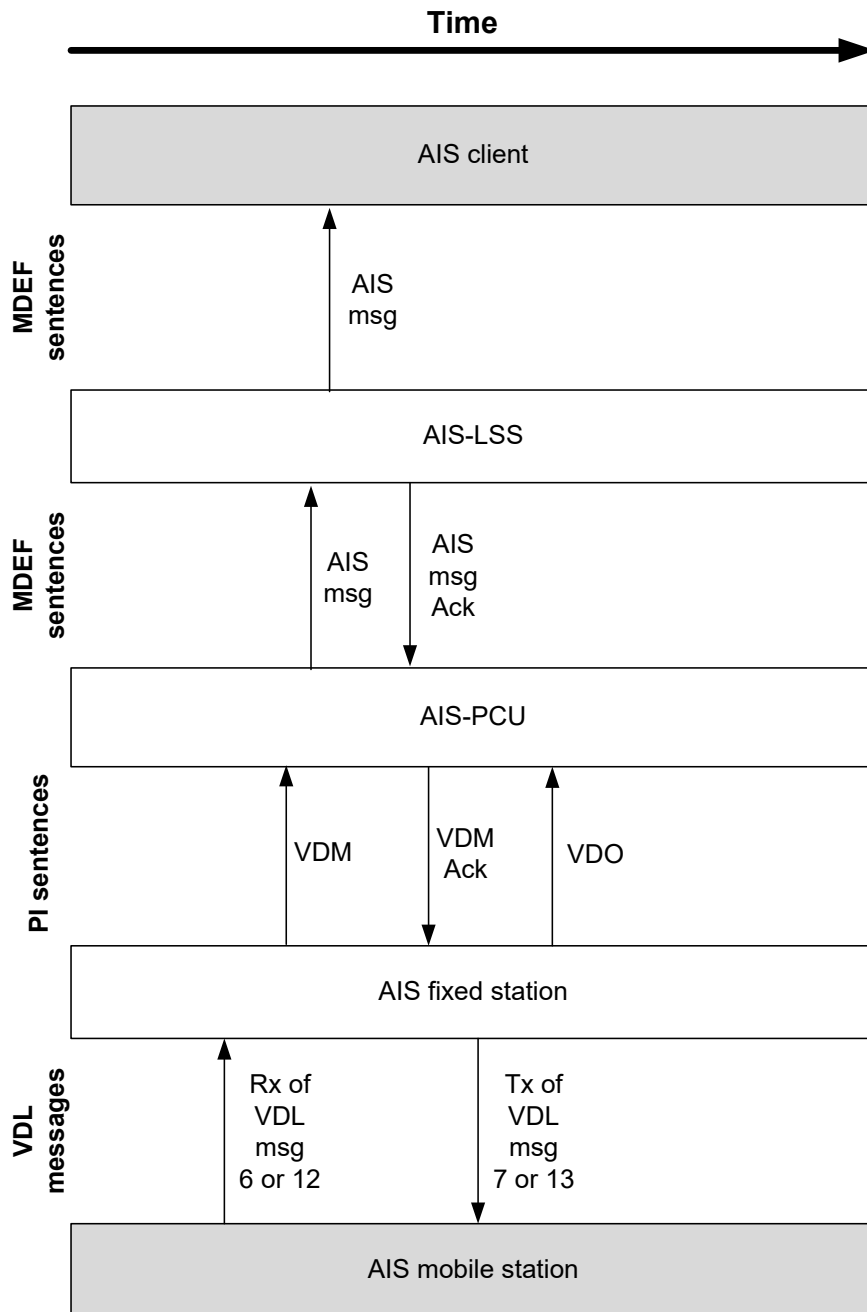

Figure 12 Interaction & data flow model for external BAS ASC\_AD, SAFE\_AD in Rx mode when addressed to MMSI of AIS client

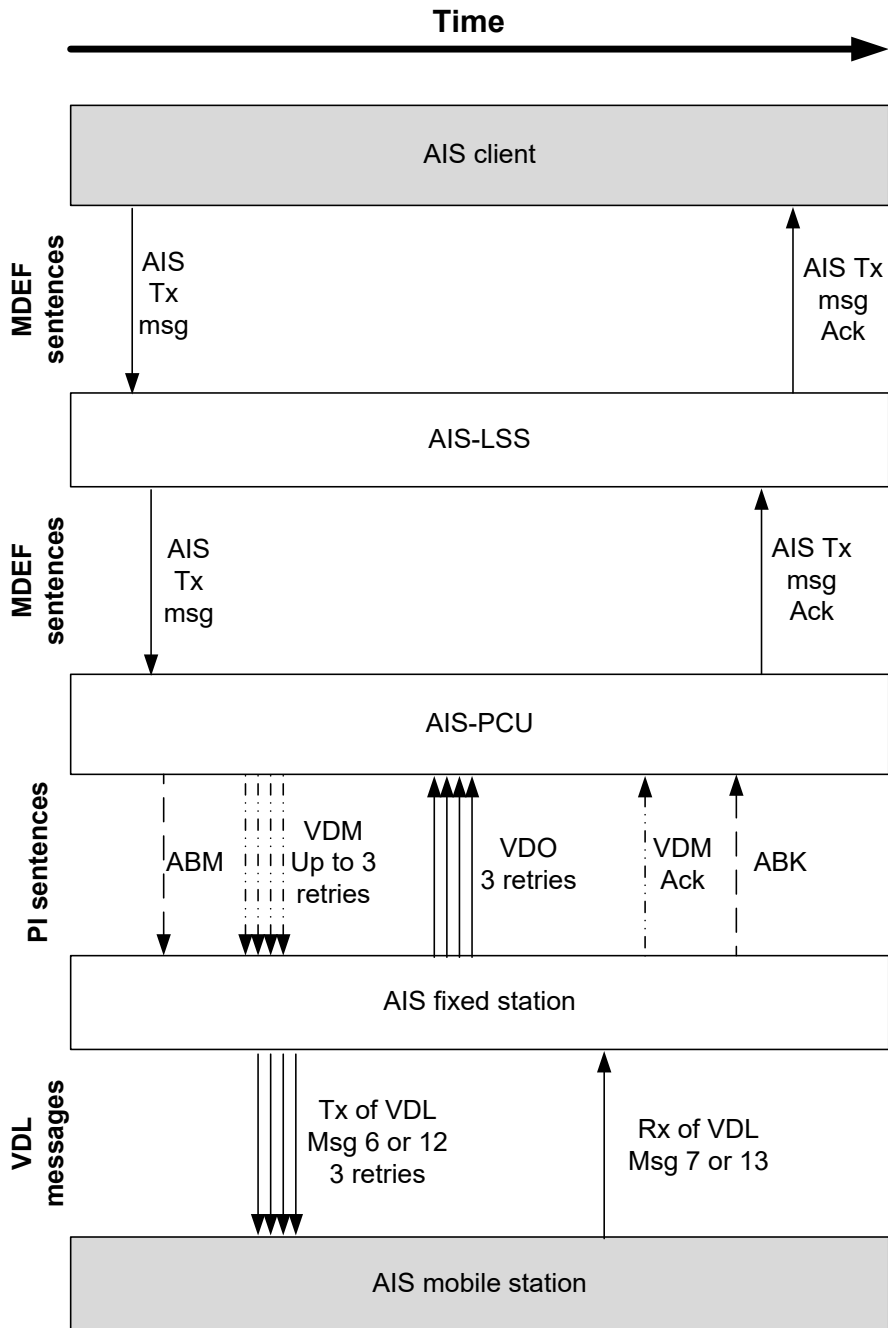

Figure 13 Interaction & data flow model for external BAS ASC\_AD, SAFE\_AD in Tx mode

### 3.4 INTERACTION AND DATA FLOW FOR EXTERNAL BAS ASC\_BR, SAFE\_BR

The external BAS services in the following table have been regrouped since they are similar in the way they require the AIS Service functional components to interact and how the data flow is created.

Table 4 ASC\_BR & SAFE\_BR service description

Service name	Tx/Rx	Description
ASC_BR	Tx & Rx	Broadcasted application specific messages
SAFE_BR	Tx & Rx	Safety related broadcasted message

Figure 14 and Figure 15 show the interaction and data flow model for external BAS ASC\_BR and SAFE\_BR in reception and transmission, respectively.

The external BAS ASC\_BR and SAFE\_BR in reception mode are triggered by the reception of a VDL message 8 or 14 by an AIS fixed station. Both messages should be sent to all AIS clients. There are no special considerations for these external BAS in reception mode other than those mentioned at the beginning of this section.

It is important to consider the case where the AIS Tx message needs to be transmitted by more than one AIS-PCU to cover the appropriate geographical region for this particular AIS Tx message. In this case, the AIS-LSS will need to process the message accordingly and send the transmission request to different AIS-PCU, as well as expect multiple acknowledgements in return. This is represented by the 'x 1' and 'x n' in Figure 15 and explained in the paragraph below. The same concern is also valid in the case where there are more than one AIS fixed stations under the control of a single AIS-PCU. The AIS-PCU should create PI sentences for all concerned fixed stations and expect multiple acknowledgements in return.

The external BAS ASC\_BR and SAFE\_BR in transmission mode are triggered by the reception of a broadcast message from an AIS client. The AIS-LSS will duplicate and route the AIS Tx message to the appropriate AIS-PCU(s) to fully cover the desired geographical broadcast zone specified in the MDEF sentence from the AIS client. The AIS-PCU(s) will transform the MDEF sentence into a BBM or a VDM PI sentence depending if the AIS fixed station is independent or dependant respectively. The AIS fixed station(s) will produce a VDO message to confirm that the VDL message 8 or 14 was indeed broadcasted. If the AIS fixed station is an independent station, it will also produce an ABK message to report the status of the broadcast.

The AIS-PCU(s) need to produce an acknowledgment that will be forwarded to the AIS-LSS. The AIS-LSS associated with the requesting AIS client must be able to gather all acknowledgements from the different broadcasting AIS-PCUs and verify that its client's request was fulfilled. A single acknowledgment per AIS Tx message containing the status of the transmission should be sent back to the client. The metadata considerations explained at the beginning of this section are especially important when sending the acknowledgment back to the client.

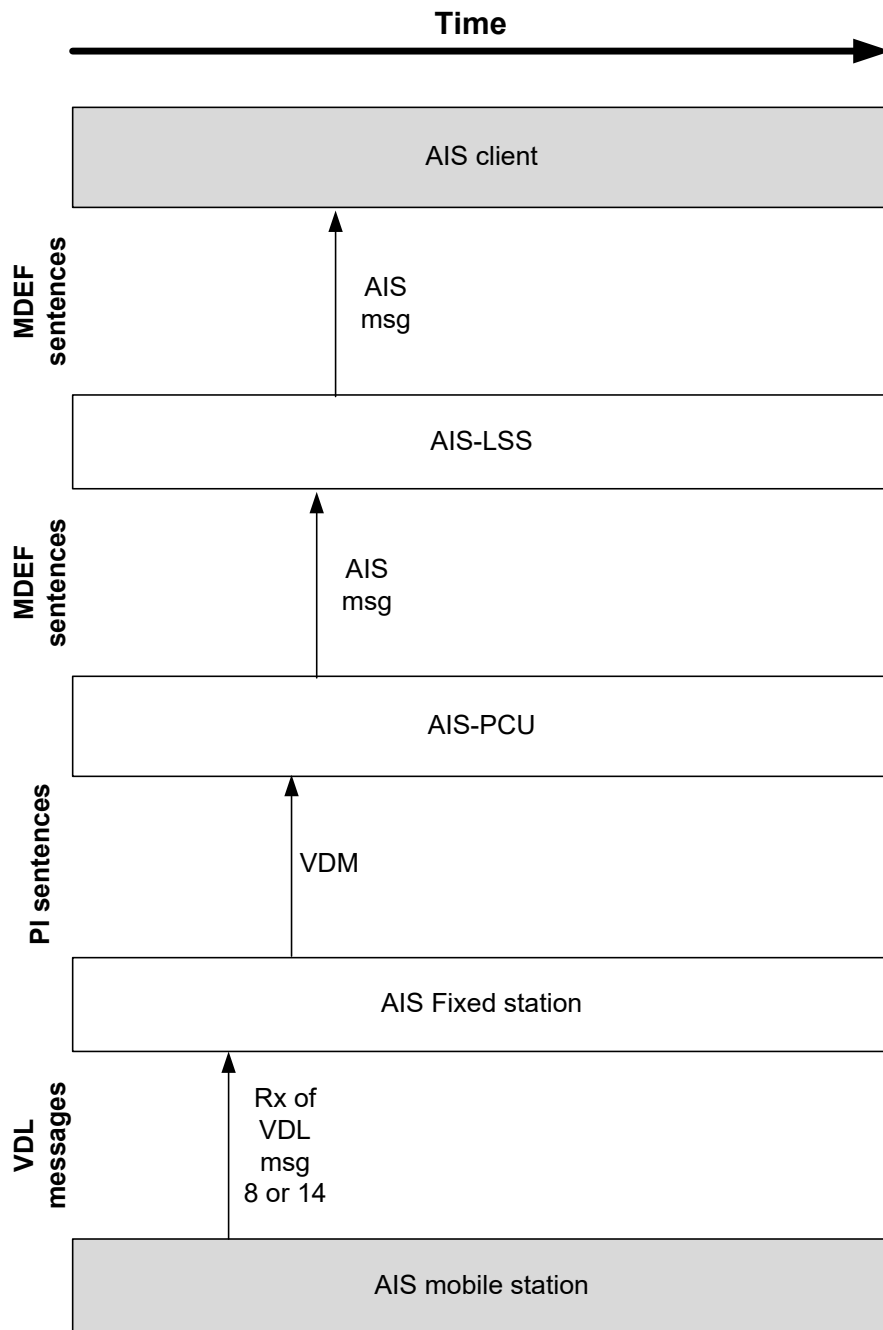

Figure 14 Interaction & data flow model for external BAS ASC\_BR, SAFE\_BR in Rx mode

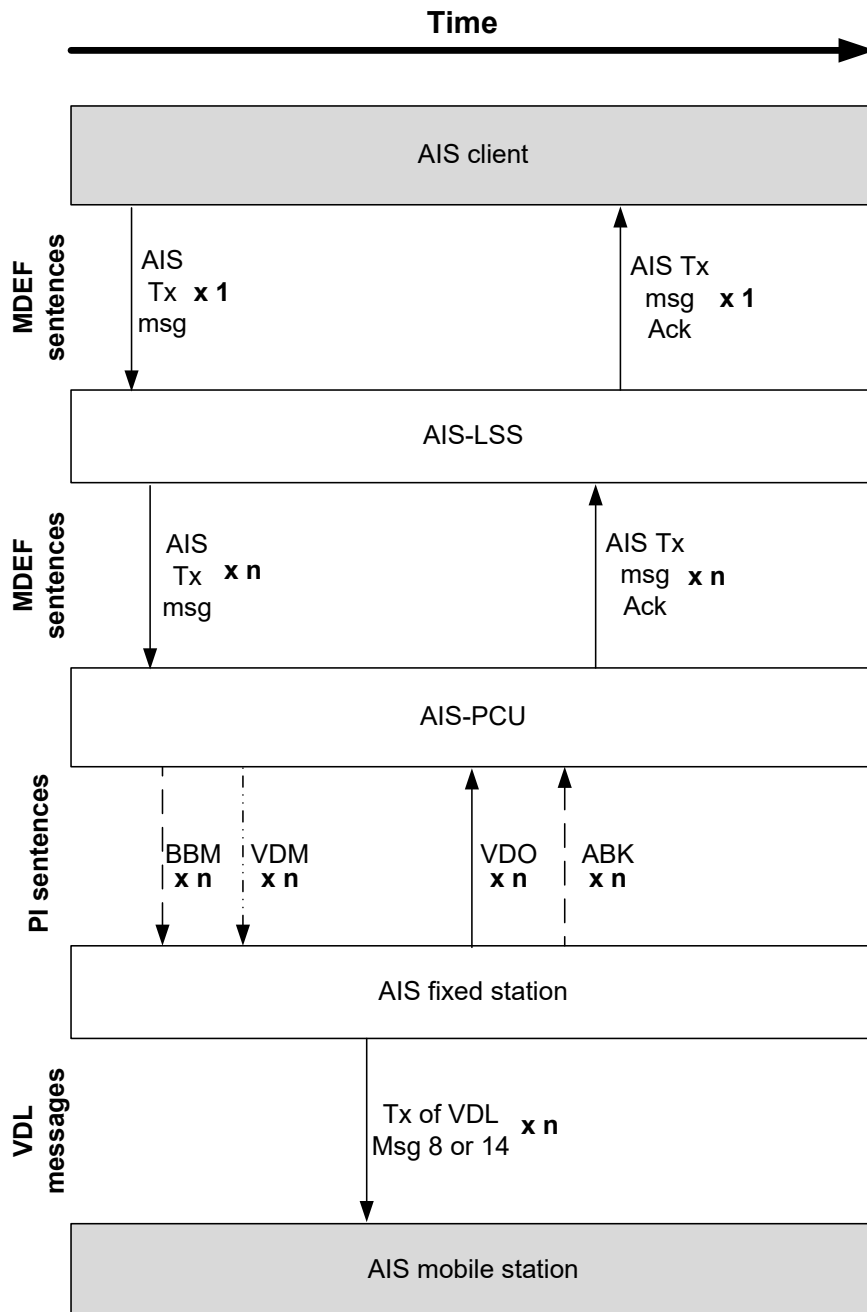

Figure 15 Interaction & data flow model for external BAS ASC\_BR, SAFE\_BR in Tx mode

### 3.5 INTERACTION AND DATA FLOW FOR EXTERNAL BAS DGNS\_COR

Table 5 DGNS\_COR service description

Service name	Tx/Rx	Description
DGNS_COR	Tx	DGNSS corrections sent through AIS

The DGNS\_COR external BAS can be used to broadcast DGNSS corrections to other AIS stations, fixed or mobile. Figure 16 on the next page shows the interaction and data flow model for external BAS DGNS\_COR.



The external BAS DGNS\_COR is triggered by the reception of DGNS data from an AIS client. The Tx DGNS data will usually be sent from an AIS client to its AIS-LSS but could also be sent from the ASM directly to the AIS-PCU if the ASM supports the management of DGNS corrections.

It is important to consider the case where the Tx DGNS data needs to be transmitted by more than one AIS-PCU to cover the appropriate geographical region for this particular set of corrections. In this case, the AIS-LSS will need to process the message accordingly and send the transmission request to different AIS-PCU, as well as expect multiple acknowledgements in return. This is represented by the 'x 1' and 'x n' in Figure 16 and explained in the paragraph below. The same concern is also valid in the case where there are more than one AIS fixed stations under the control of a single AIS-PCU. The AIS-PCU should create PI sentences for all concerned fixed stations and expect multiple broadcast confirmations in return.

The AIS-LSS will duplicate and route the Tx DGNS data to the appropriate AIS-PCU(s) to fully cover the desired geographical broadcast zone specified in the MDEF sentence from the AIS client. The AIS-PCU(s) will transform the MDEF sentence into a VDM PI sentence and forward it to the appropriate AIS fixed station(s). The AIS fixed station(s) will produce a VDO message to confirm that the VDL message 17 was indeed broadcasted.

The AIS-PCU(s) need to produce an acknowledgment that will be forwarded to the AIS-LSS. The AIS-LSS associated with the requesting AIS client must be able to gather all acknowledgements from the different broadcasting AIS-PCUs and verify that its client's request was fulfilled. A single acknowledgement per AIS Tx message containing the status of the transmission should be sent back to the client. The metadata considerations explained at the beginning of this section are especially important when sending the acknowledgement back to the client.

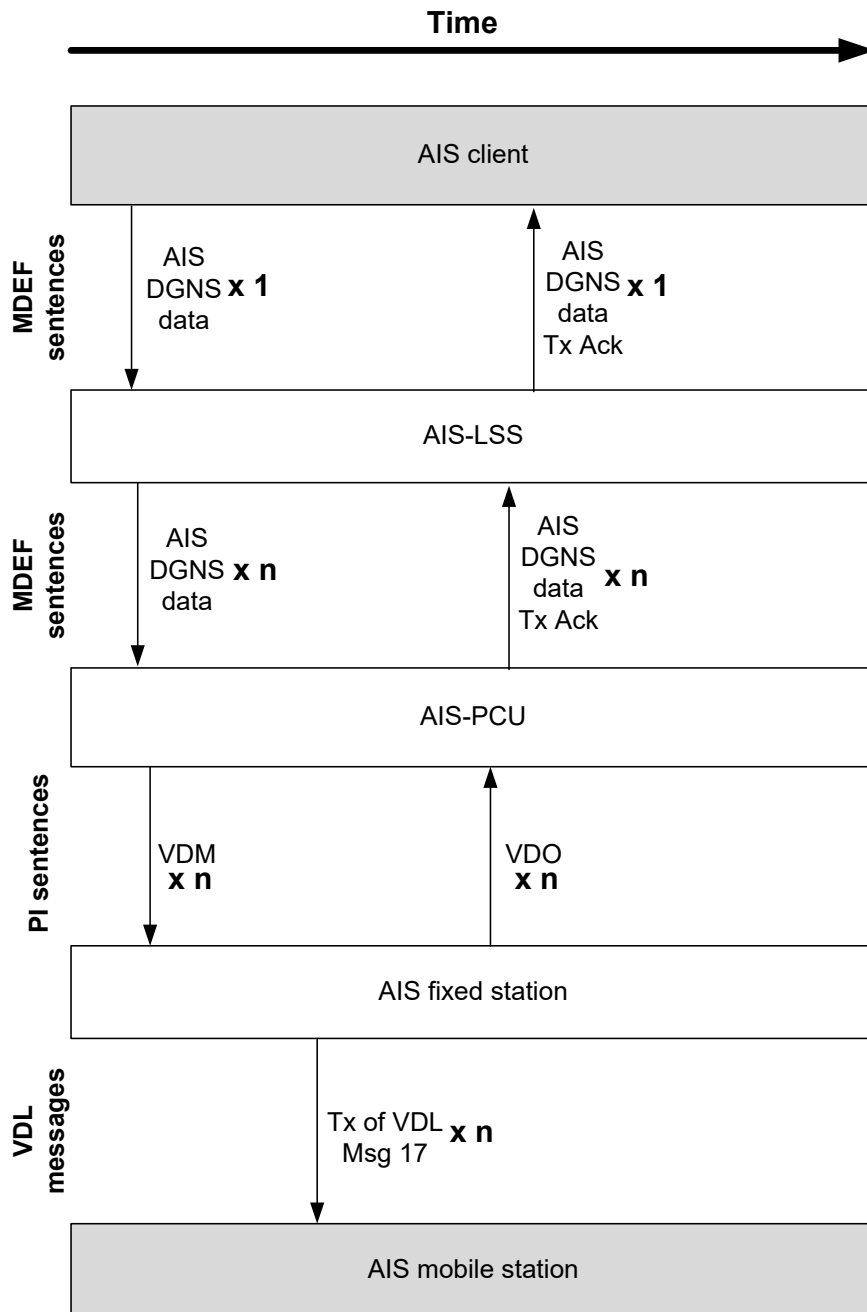

Figure 16 Interaction & data flow model for external BAS DGNS\_COR

### 3.6 INTERACTION AND DATA FLOW FOR EXTERNAL BAS INT\_TDAMA

Table 6 INT\_TDAMA service description

Service name	Tx/Rx	Description
INT_TDAMA	Tx	Interrogation via AIS VDL

The INT\_TDAMA external BAS can be used to interrogate AIS stations for specific VDL messages. The reader should refer to the description of VDL message 15 in ITU 1371-3 for a table of the possible interrogations available.

Figure 17 shows the interaction and data flow model for external BAS INT\_TDAMA.

With a single VDL message 15, it is possible to interrogate 2 different AIS stations, for a total of 3 different VDL messages responses. This increases considerably the complexity of external BAS INT\_TDMA, especially when considering that a client might request interrogations from 2 different AIS stations not located within the same AIS-PCU coverage zone. Efforts should be made in the design of the AIS system to shield the AIS client from this complexity, allowing him to request only one (1) interrogation per MDEF sentence sent to the AIS Service. The AIS-PCU should be left with the burden of creating an optimized VDL message 15 depending on the different, simultaneous, requests it receives from the AIS-LSS(s). We will assume this is the case for the remainder of this discussion.

The external BAS INT-TDMA is triggered by the reception of a MDEF sentence query message from an AIS client. The AIS-LSS will route the query message to the most appropriate AIS-PCU for the location of the target. In turn, the AIS-PCU will route its PI sentences to the most appropriate AIS fixed station. If the AIS fixed station is an independent station, the AIS-PCU will send an AIR PI sentence to the fixed station. If the AIS fixed station is a dependant station, the AIS-PCU will have to send VDM PI sentences to instruct the fixed station to broadcast a VDL message 15. Both types of fixed stations will output a VDO PI sentence after broadcasting the VDL message 15. After the reception of the requested VDL message, both types of fixed stations will also output a VDM PI sentence with the content of the requested VDL message. The content must be forwarded to the AIS-LSS and its requesting client by the AIS-PCU using MDEF sentences.

An independent AIS fixed station will also produce an ABK PI sentence to acknowledge the reception of the requested VDL message or signal the failure of the operation. Depending on the result of the overall operation, the AIS-PCU will have to send an acknowledgment to the AIS-LSS to update its client. The reception of both the requested message and the acknowledgement should be used as indicators that the transaction was successful.



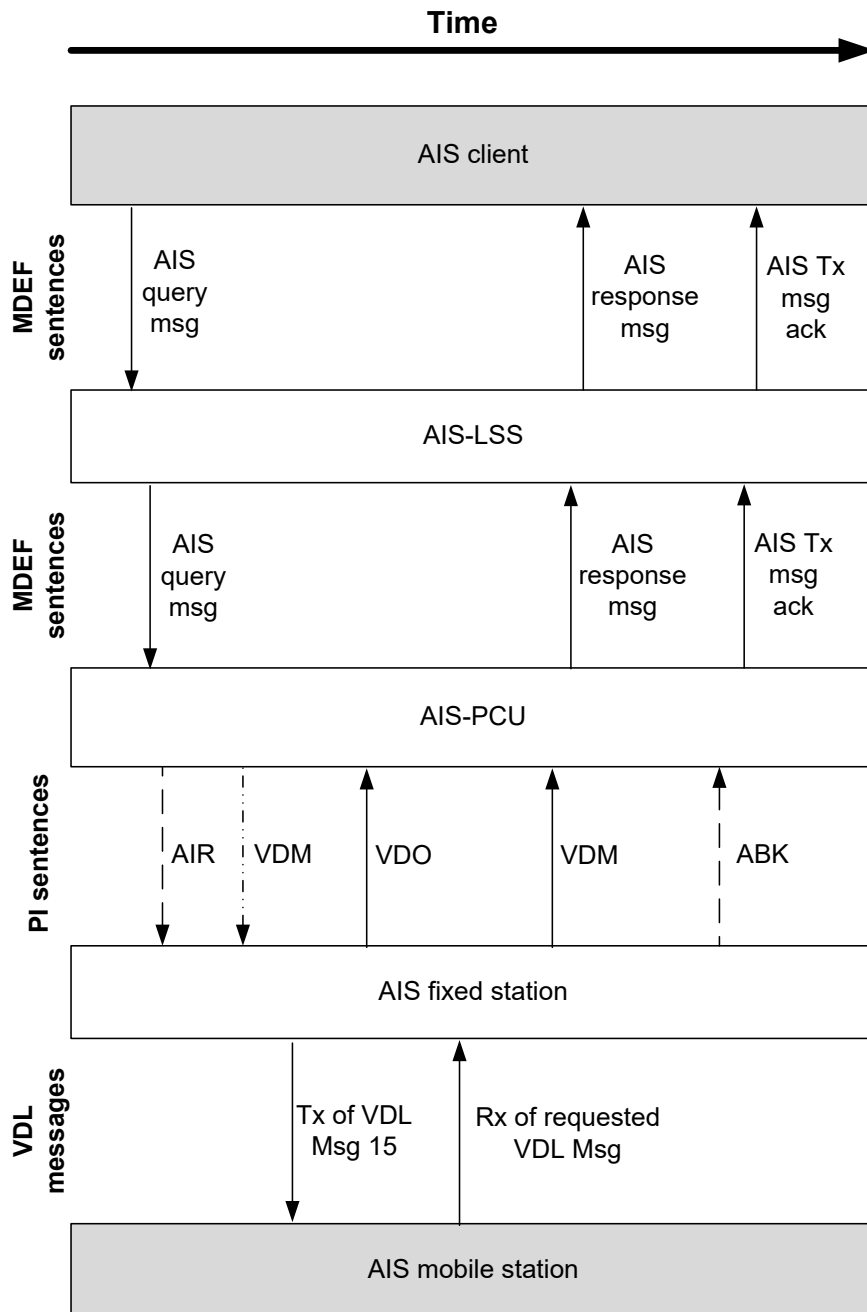

Figure 17 Interaction & data flow model for external BAS INT\_TDMA

### 3.7 INTERACTION AND DATA FLOW FOR EXTERNAL BAS ASGN\_RATE

Table 7 ASGN\_RATE service description

Service name	Tx/Rx	Description
ASGN_RATE	Tx	Assignment of report rate and slot to specific mobile unit

The ASGN\_RATE external BAS can be used to assign AIS stations an increased reporting rate. The reader should refer to the description of VDL message 16 in ITU 1371-3 for details of how this message works.

Figure 18 shows the interaction and data flow model for external BAS ASGN\_RATE.

With a single VDL message 16, it is possible to assign 2 AIS stations different reporting rates. This increases considerably the complexity of external BAS ASGN\_RATE, especially when considering that a client might send assignments for 2 different AIS stations not located within the same AIS-PCU coverage zone. Efforts should be made in the design of the AIS system to shield the AIS client from this complexity, allowing him to send only one (1) assignment per MDEF sentence sent to the AIS Service. The AIS-PCU should be left with the burden of creating an optimized VDL message 16 depending on the different, simultaneous, assignments it receives from the AIS-LSS(s). We will assume this is the case for the remainder of this discussion.

The external BAS ASGN\_RATE is triggered by the reception of a MDEF sentence assignment message from an AIS client. The AIS-LSS will route the assignment message to the most appropriate AIS-PCU for the location of the target. In turn, the AIS-PCU will route its PI sentences to the most appropriate AIS fixed station. If the AIS fixed station is an independent station, the AIS-PCU will send an ASN PI sentence to the fixed station. If the AIS fixed station is a dependant station, the AIS-PCU will have to send VDM PI sentences to instruct the fixed station to broadcast a VDL message 16. Both types of fixed stations will output a VDO PI sentence after broadcasting the VDL message 16. At this point the AIS-PCU should be able to detect if the assignment was received by the targeted mobile station and send a message to the AIS-LSS and its client if the assignment failed.

If the assignment was received, the targeted AIS mobile station will start to broadcast its position reports at the specified rate, only if the rate is higher than its autonomously determined report rate. In either case, the assign mode indicator flag will be activated so that other AIS stations are aware that it is in assign mode. The assign mode will last for a random interval of 4 to 8 minutes. In the case of a class A mobile, VDL message 2 will be broadcasted instead of message 1 and there are no assign mode flag. The increased report rate position reports should be forwarded to all allowed AIS clients and not just the client who requested the assignment.

After the end of the assignment, the AIS-PCU will have to send a message to indicate the end of the assignment. The message should only be forwarded to the client who made the assignment.

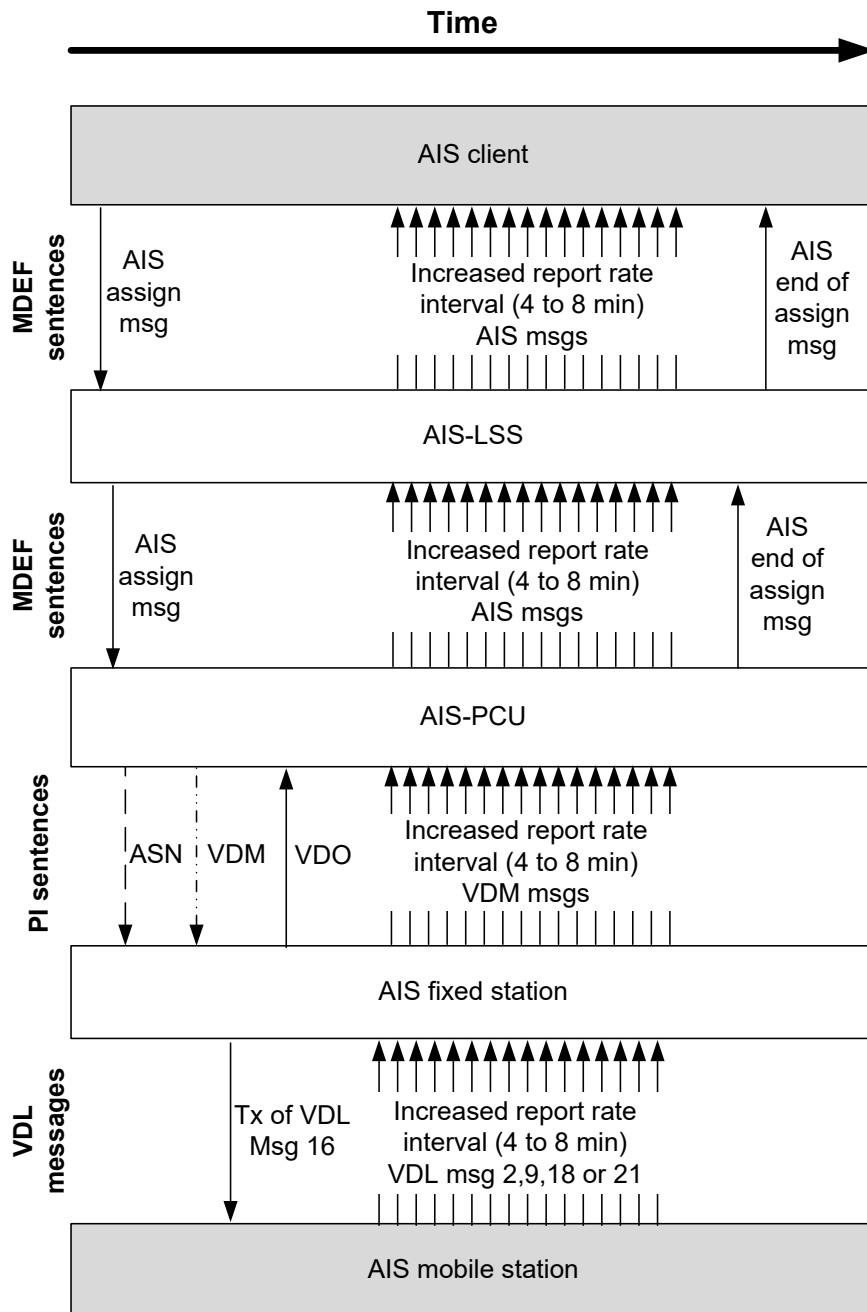

Figure 18 Interaction & data flow model for external BAS ASGN\_RATE

### 3.8 INTERACTION AND DATA FLOW FOR EXTERNAL BAS ASGN\_GROUP

Table 8 ASGN\_GROUP service description

Service name	Tx/Rx	Description
ASGN_GROUP	Tx	Assignment of transmission parameters to group of mobile

The ASGN\_GROUP external BAS can be used to assign a group of AIS stations an increased reporting rate. The reader should refer to the description of VDL message 23 in ITU 1371-3 for details of how this message works.

Figure 19 on the next page shows the interaction and data flow model for external BAS ASGN\_GROUP.

The external BAS ASGN\_GROUP is triggered by the reception of a group assignment message from an AIS client. The group assignment is usually a temporary assignment and will usually be sent from an AIS client to its AIS-LSS when required. But it could also be sent from the ASM directly to the AIS-PCU, or even originate from the AIS-PCU itself if configured that way and if the ASM supports the management of permanent group assignments.

It is important to consider the case where the group assignment message needs to be transmitted by more than one AIS-PCU to cover the specified geographical region. In this case, the AIS-LSS will need to process the message accordingly and send the transmission request to different AIS-PCU, as well as expect multiple transmit acknowledgements in return. This is represented by the 'x 1' and 'x n' in Figure 19 and explained in the paragraph below. The same concern is also valid in the case where there are more than one AIS fixed stations under the control of a single AIS-PCU. The AIS-PCU should create PI sentences for all concerned fixed stations and expect multiple broadcast confirmations in return.

The AIS-LSS will duplicate and route the group assignment message to the appropriate AIS-PCU(s) to fully cover the specified geographical area specified in the MDEF sentence from the AIS client. The AIS-PCU(s) will transform the MDEF sentence into VDM PI sentences and route them to the appropriate AIS fixed station(s). If the AIS fixed station is an independent station, the AIS-PCU will send an ASN PI sentence to the fixed station. If the AIS fixed station is a dependant station, the AIS-PCU will have to send a VDM PI sentence to instruct the fixed station to broadcast a VDL message 23. Both types of fixed stations will output a VDO PI sentence after broadcasting the VDL message 23.

The AIS-PCU(s) need to produce an acknowledgment that the group assignment message was indeed broadcasted. The AIS-LSS associated with the requesting AIS client must be able to gather all acknowledgements from the different broadcasting AIS-PCUs and verify that its client's request was fulfilled. A single acknowledgement per group assignment request should be sent back to the client. The metadata considerations explained at the beginning of this section are especially important when sending the acknowledgement back to the client.

If the assignment was received, the targeted AIS mobile station(s) will start to broadcast position reports at the specified rate. Class A AIS mobiles will only apply the assignment if the assigned rate is higher than the autonomously determined report rate. In either case, the assign mode indicator flag will be activated so that other AIS stations are aware that they are in assign mode. The assign mode will last for a random interval of 4 to 8 minutes. In the case of class A mobiles, VDL message 2 will be broadcasted instead of message 1 and there are no assign mode flag. The increased report rate position reports should be forwarded to all allowed AIS clients and not just the client who requested the group assignment. The AIS client could also have requested a quiet time of up to 15 minutes. The client is responsible to detect the end of the group assignment / quiet time and request another one if desired.

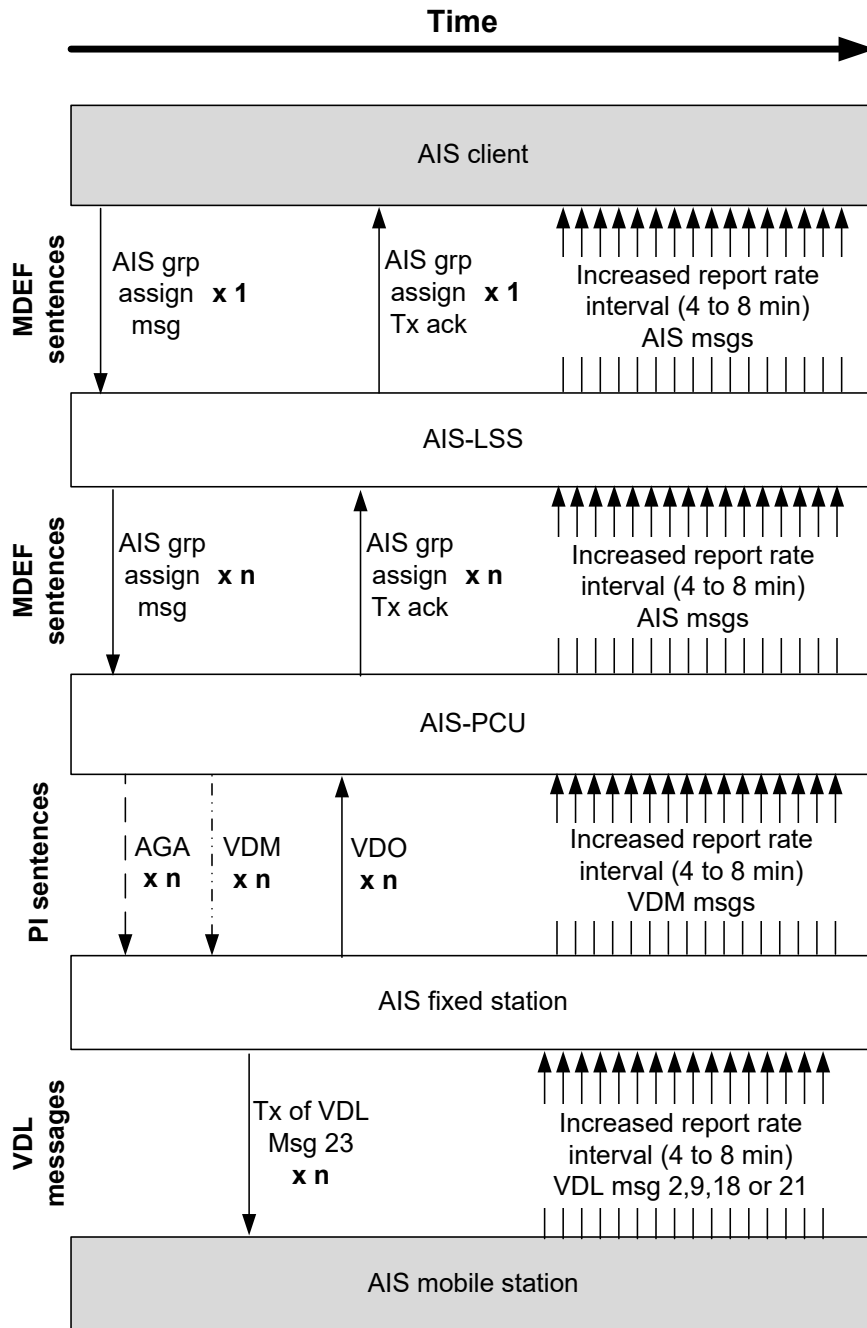

Figure 19 Interaction & data flow model for external BAS ASGN\_GROUP

### 3.9 INTERACTION AND DATA FLOW FOR EXTERNAL BAS AIS\_MON

Table 9 AIS\_MON service description

Service name	Tx/Rx	Description
AIS_MON	Rx	Monitoring of AIS Service and VDL to provide status to AIS clients

The AIS\_MON external BAS can be used to monitor the status of the AIS Service, its components and the VDL.

Figure 20 shows the interaction and data flow model for external BAS AIS\_MON.

There are 5 different status reports that an AIS client could be interested in. All these statuses could have an impact on operational decisions and the validity, integrity and completeness of the received AIS data from the AIS Service. The following are the different status reports available to an AIS client:

- 1 The status of the VDL as reported by each AIS fixed station in FSR PI sentences.
- 2 The status of the connection to the AIS fixed stations validated by the reception of ADS sentences.
- 3 The status of the AIS fixed stations reported by the ALR PI sentences from each fixed station.
- 4 The status of the AIS-PCU(s) reported by appropriate MDEF sentences.
- 5 The status of the AIS-LSS(s) reported by appropriate MDEF sentences.

Both the FSR and the ADS sentences contain a field with the unique identifier of the AIS fixed station making it easy to identify from which station the report comes from. Such is not the case for the ALR sentences and alternative solutions, such as the use of comment blocks, should be considered to associate these sentences with the originating fixed station before the information is passed on to higher layers.

It should also be mentioned that the ADS sentence is strongly recommended to determine the availability of the connection to a particular fixed station and detect network failures. Although it might be tempting to use the fixed station's VDO messages, especially in the case of AIS base stations, this should be avoided as there are a number of good reasons why a base station would not be broadcasting, temporarily or permanently.

It is recommended that the frequency at which these sentences and reports are passed on to the AIS clients be configurable. Since the same reports and sentences will be used for the internal BAS as well, it is not recommended to design the AIS Service such that only the output of the reports and sentences are configurable on the components themselves. It is important to consider that the internal BAS may have different monitoring requirements than AIS clients.

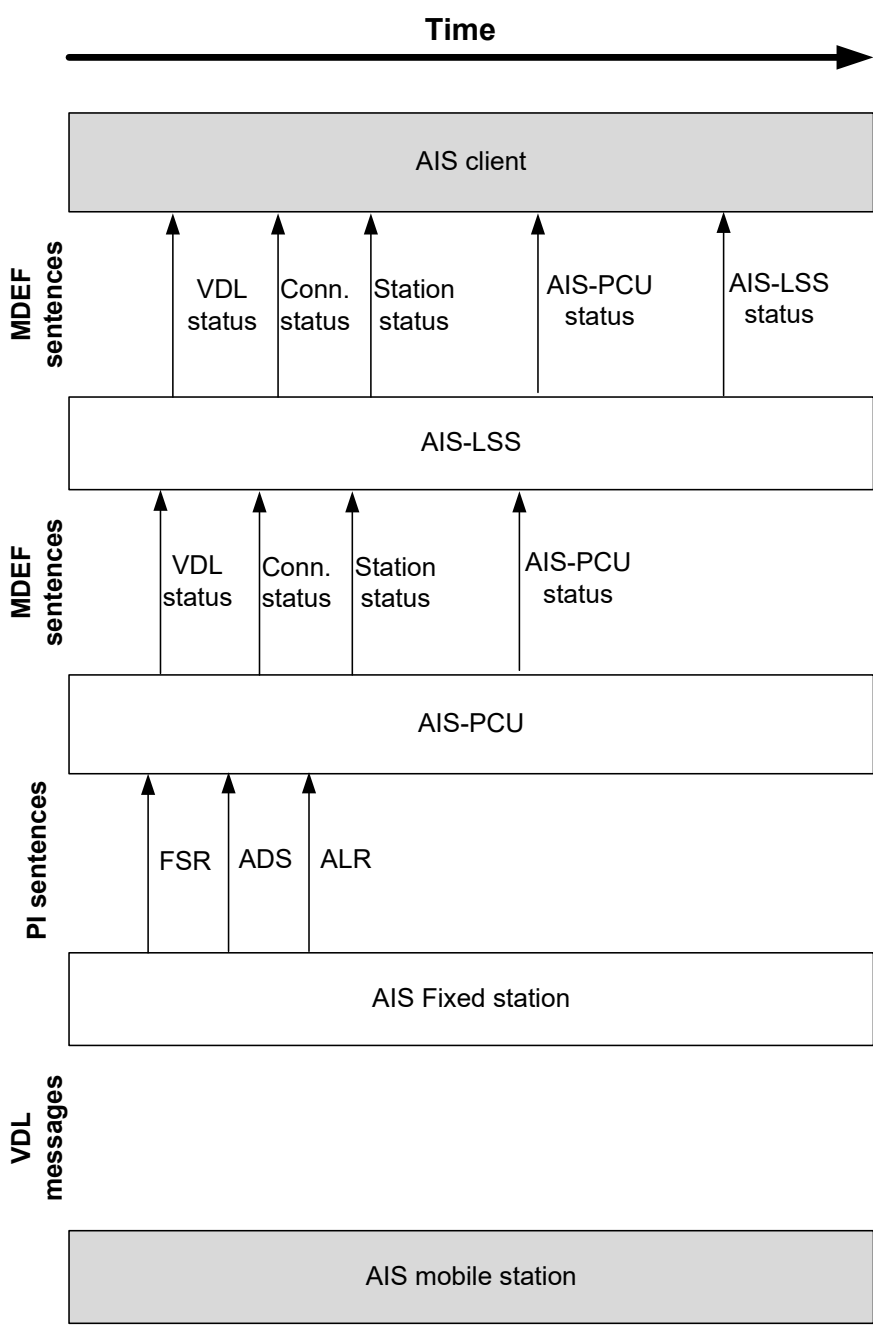

Figure 20 Interaction & data flow model for external BAS AIS\_MON

## 4 INTERACTION AND DATA FLOW FOR THE INTERNAL BAS

This chapter describes the interaction and data flow for the internal BAS. As shown in Figure 21, the template diagram used extensively in the previous chapter has been slightly modified to include the ASM since it will play a major role in the interactions and data flow of the internal BAS. The time axis is still important, although the interactions of internal BAS are less time sensitive than the external BAS and most will happen at predefined intervals. The same different types of lines will be used to identify the interactions between the AIS-PCU and the dependant or independent types of AIS fixed stations. Again, it is important to remember that all independent AIS fixed stations should be compatible with the interactions described for a dependant fixed station. The inverse is not true.

It is also important to mention that some internal BAS have been regrouped for simplicity since the interactions and data flow is identical for these internal BAS.

In most external BAS cases, it is important to have access to metadata on the origin of the data such as from which AIS fixed station the status messages are coming, or to which AIS fixed station the configuration messages are addressed. In order to fulfil this requirement the unique identifier of the AIS fixed station can be appended to the PI sentence using comment blocks as defined in IEC 62320-1. Other data such as a timestamp can also be inserted in the comment blocks if required. The presence of such information should be detected by the AIS-PCU and forwarded accordingly in the MDEF sentences.

The ASM may also need to know from which AIS-PCU or AIS-LSS (in a hierarchical topology) the data originated from. In those cases the MDEF sentences should contain the appropriate fields to be forwarded to the ASM.

*These considerations are valid for all internal BAS and will not be repeated in the description of each BAS.*



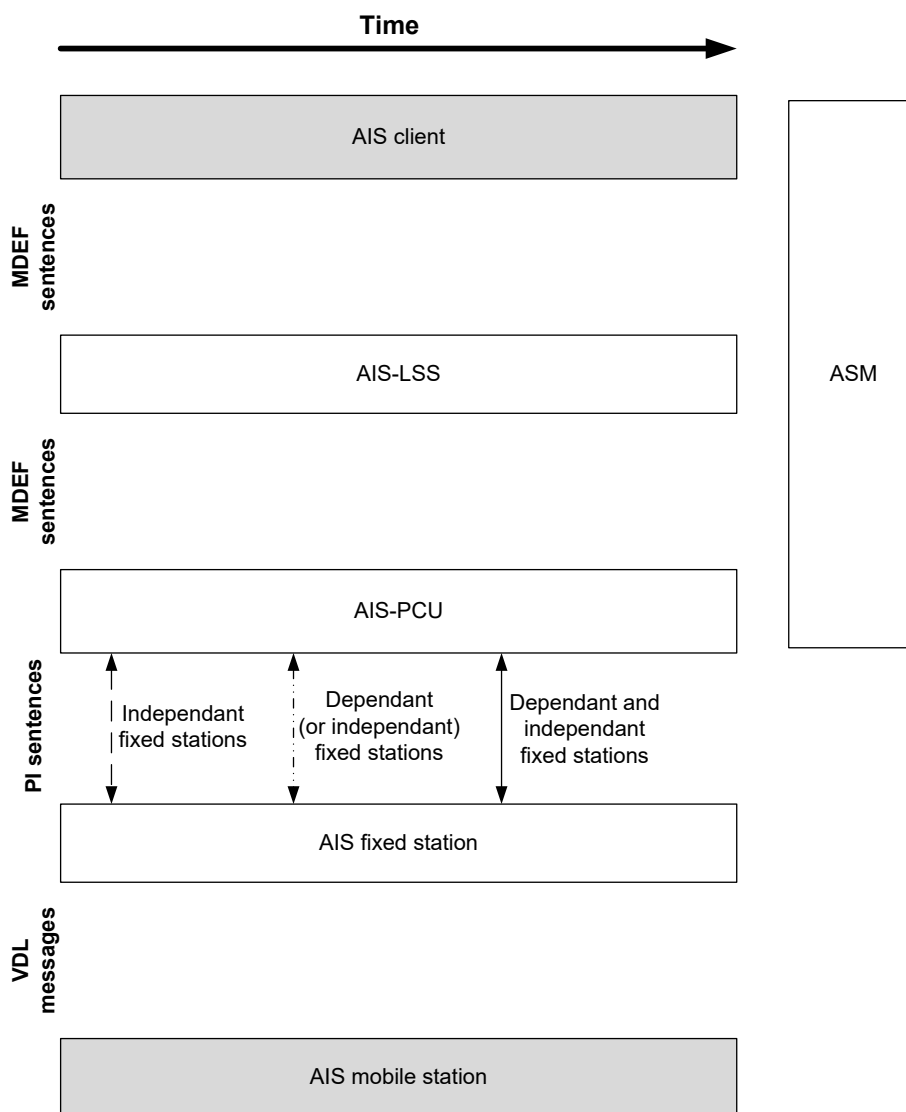

Figure 21 Template for internal BAS interaction & data flow model

## 4.1 INTERACTION AND DATA FLOW FOR INTERNAL BAS INIT\_AIS, TERM\_AIS, LSS\_MGMT, PCU\_MGMT, STA\_MGMT

The internal BAS services in the following table have been regrouped since they are similar in the way they require the AIS Service functional components to interact and how the data flow is created. The interactions and data flow are triggered by the reception of the corresponding messages by the ASM.

Table 10 Description of management & configuration services

Service name	Description
INIT_AIS	<i>Initiate, restart and reset AIS service</i>
TERM_AIS	<i>Terminate AIS service</i>
LSS_MGMT	<i>Management and configuration of AIS-LSS</i>
PCU_MGMT	<i>Management and configuration of AIS-PCU</i>
STA_MGMT	<i>Management and configuration of AIS Fixed Station</i>

The interaction and data flow model for the above internal BAS is shown in Figure 22 on the next page. These messages should be acknowledged by the AIS-LSS and the AIS-PCU. Status monitoring of these components available with internal BAS AIS\_MON can also be used to confirm the reception of these messages. Confirmation of configuration of the AIS fixed station should be done by using the BASE\_DAT internal BAS and associated query sentences.

The initiate and terminate messages used for the AIS-PCU have no equivalent on the AIS fixed station PI. The reason is that depending on the configuration of the AIS service a number of scenarios are possible that will require the AIS-PCU to interface with elements that are not part of the AIS functional components. For example, the AIS-PCU may need to use an antenna relay switch to allow the AIS fixed station to interface to the RF domain. Hence, the required messages to initiate and terminate the AIS fixed station appropriately are left to the designer of the AIS Service.

It is important to note that configuration and management of the AIS fixed stations is not sent directly to the AIS fixed station but send first to the AIS-PCU who will create the appropriate PI sentences. The AIS fixed station configuration PI sentences used in this internal BAS are considered to be general configuration options and apply to both dependant and independent AIS fixed stations. VDL specific configuration sentences are discussed in internal BAS FATDMA and CH\_MGMT.

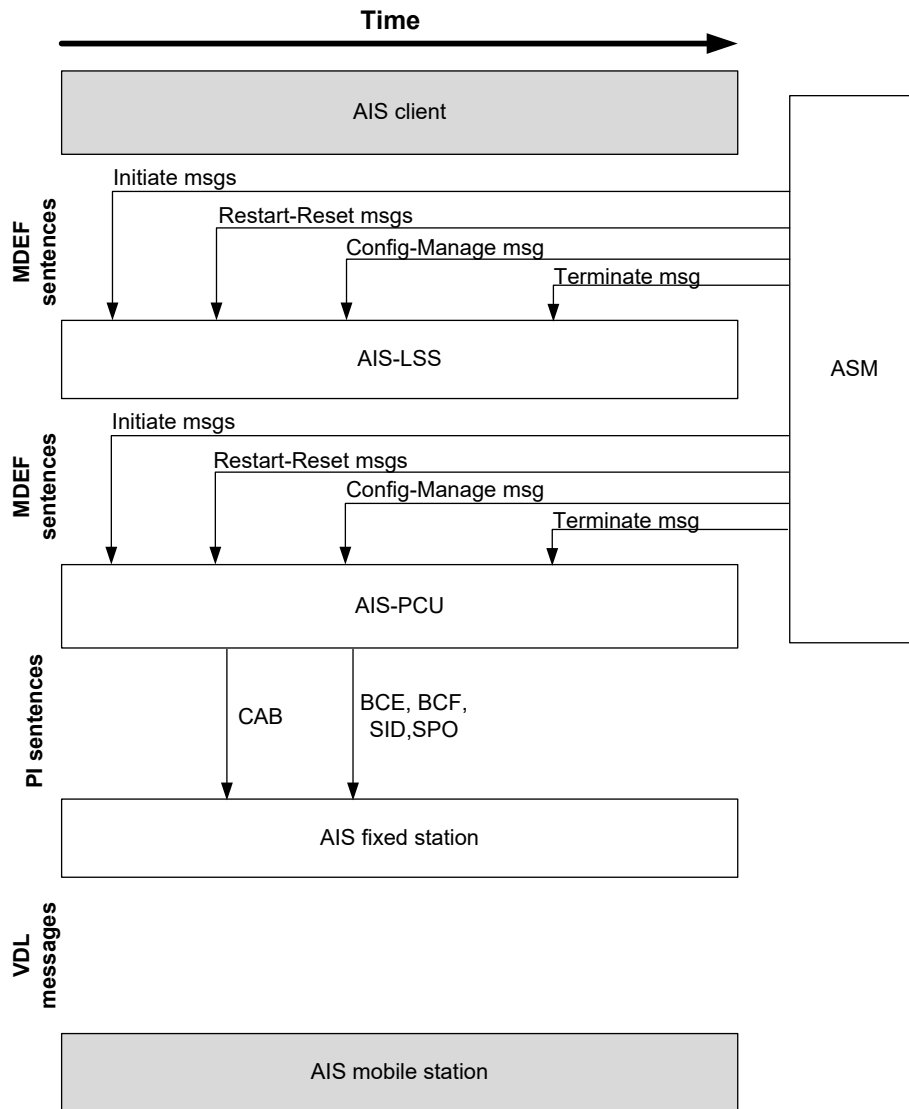

Figure 22 Interaction & data flow model for internal BAS INIT\_AIS, TERM\_AIS, LSS\_MGMT, PCU\_MGMT and STA\_MGMT.

## 4.2 INTERACTION AND DATA FLOW FOR INTERNAL BAS BASE\_DAT

Table 11 BASE\_DAT description

Service name	Description
BASE_DAT	Base station data

The interaction and data flow model for the internal BAS BASE\_DAT is shown in Figure 23.

The internal BAS BASE\_DAT is used to obtain current general configuration of an AIS fixed station. This service can be used by any functional component of the AIS Service to obtain information on the configuration of the AIS fixed station. Hence, AIS-PCU, AIS-LSS and ASM can all query for the configuration information if it is required. If sent by the AIS-LSS or the ASM, the query should be sent to the AIS-PCU who will query the appropriate AIS fixed station if required.

The use of the PI sentence ABQ is used by the AIS-PCU to query the AIS fixed station. In the cases of sentences ACA, DLM and ECB, the AIS-PCU should only query independent fixed stations as this configuration information is managed by the AIS-PCU itself for dependant fixed stations. Both types of fixed stations can be queried for the other sentences: BCE, BCF, CAB, SPO and VER.

The information received from the PI sentences must be transferred to appropriate MDEF sentences by the AIS-PCU to be sent to the originator of the request, AIS-LSS or ASM.

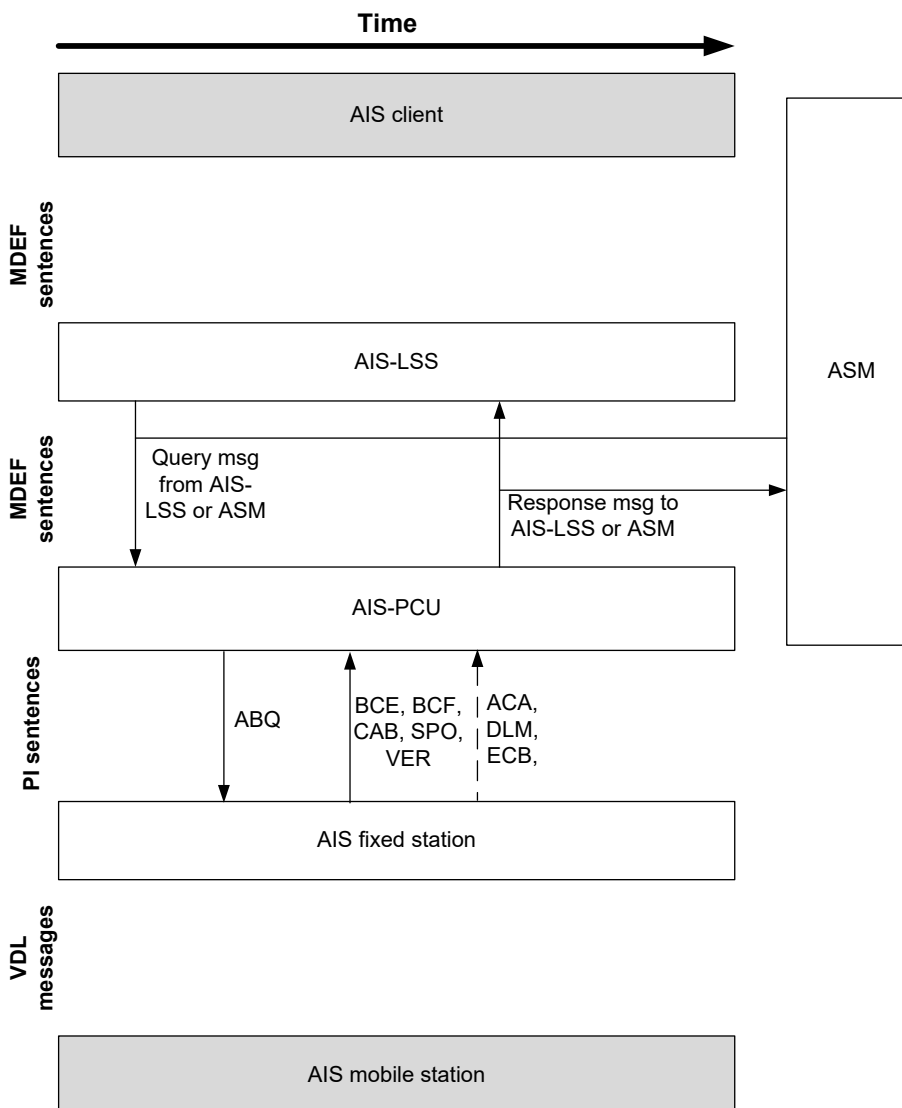

Figure 23 Interaction & data flow model for internal BAS BASE\_DAT

### 4.3 INTERACTION AND DATA FLOW FOR INTERNAL BAS FATDMA AND CH\_MGMT

The internal BAS services in the following table have been regrouped since they are similar in the way they require the AIS Service functional components to interact and how the data flow is created. The interactions and data flow are triggered by the reception of the corresponding messages by the ASM.

Table 12 FATDMA & CH\_MGMT service description

Service name	Description
FATDMA	Base station FATDMA reservations
CH_MGMT	Channel management of VDL

The interaction and data flow model for the above internal BAS is shown in Figure 24. These messages originate from the ASM and should be acknowledged by the AIS-PCU.

The internal BAS FATDMA is initiated by a slot allocation configuration message sent by the ASM to the AIS-PCU. If the AIS fixed station is an independent station, the AIS-PCU will create a DLM PI message to send the configuration to the fixed station. If the fixed station is a dependant station, the AIS-PCU will keep the configuration internally and generate VDM sentences appropriately for the AIS fixed station to broadcast VDL message 20. Both types of stations will generate a VDO sentence to confirm the broadcast of VDL message 20.

The internal BAS CH\_MGMT is initiated by a channel management message sent by the ASM to the AIS-PCU. If the AIS fixed station is an independent station, the AIS-PCU will create an ACA PI message to send the configuration to the fixed station. If the fixed station is a dependant station, the AIS-PCU will keep the configuration internally and generate VDM sentences appropriately for the AIS fixed station to broadcast VDL message 22. The PI sentence CAB can also be used by the AIS-PCU to instruct the AIS fixed station that transmission on the different AIS VHF channels is allowed or not. This can be a permanent measure or a temporary measure. Both types of stations will generate a VDO sentence to confirm the broadcast of VDL message 22.

Although not recommended, it is also possible to use an ACM PI message to send an addressed channel management message to one or two specific AIS stations. Administrations should use proper caution when using the ACM sentence or an addressed message 22 because of the consequences it can have on the AIS stations, essentially making them invisible to other AIS stations. More information on channel management is available in appendix 17.

The ASM should provide the appropriate Human Machine Interfaces (HMI) to allow the technical personnel to configure and manage the slot allocation and channels management in an integrated, AIS Service-wide way. This usage of this HMI by technical personnel should be the original trigger of the interactions and data flow explained above.

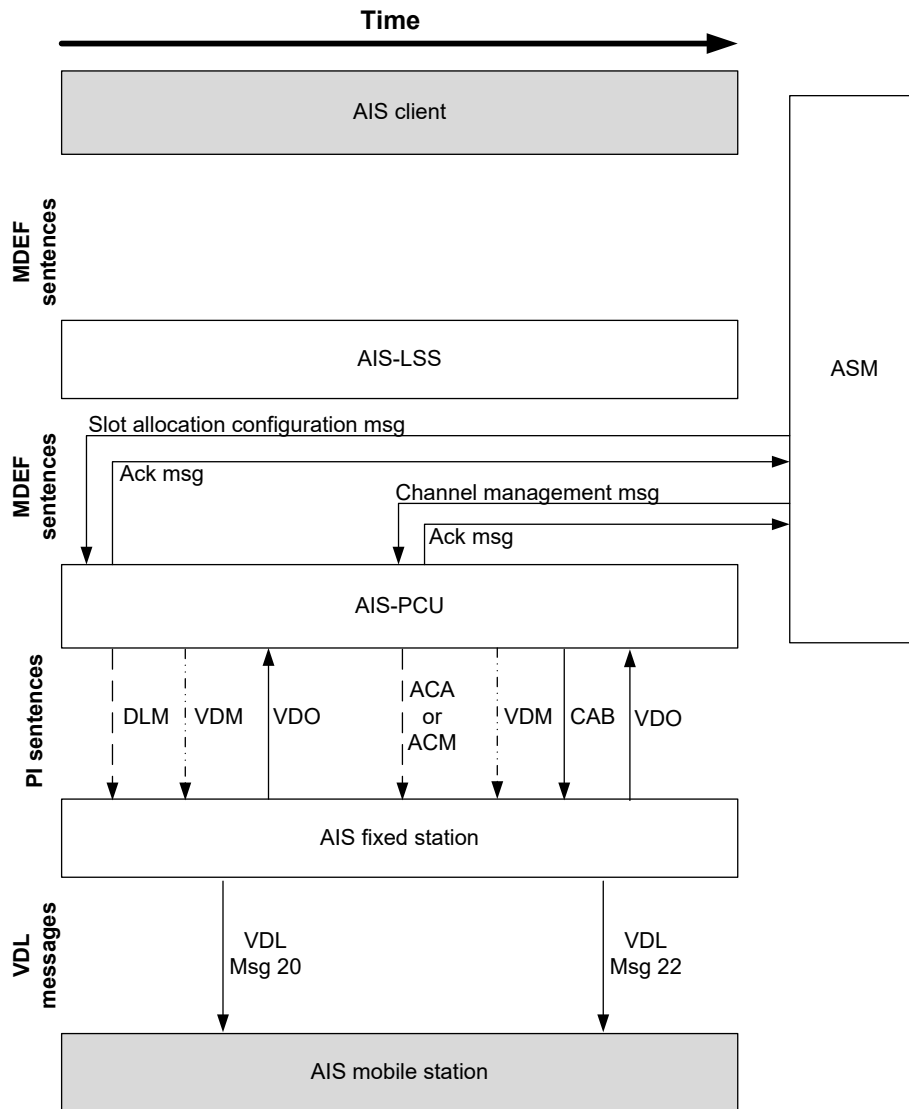

Figure 24 Interaction & data flow model for internal BAS FATDMA and CH\_MGMT

## 4.4 INTERACTION AND DATA FLOW FOR INTERNAL BAS AIS\_MON

Table 13 AIS\_MON service description

Service name	Description
AIS_MON	Monitoring of AIS Service and VDL

The AIS\_MON internal BAS can be used to monitor the status of the AIS Service, its components and the VDL. This service is especially important since it can affect the behaviour of all AIS functional components as it is directly related to the internal real-time data flow that might affect internal or external BAS. AIS components status monitoring will influence data flow routing decisions for all components and allow them to use alternate interactions to re-route the data flow appropriately in case of component failures.

Figure 25 shows the interaction and data flow model for internal BAS AIS\_MON.

There are 7 different interactions for the internal BAS AIS\_MON. They are explained below:

- 1 The status of the VDL as reported by each AIS fixed station in FSR PI sentences should be sent to all AIS-LSS as well as to the ASM.
- 2 The status of the connection to the AIS fixed stations validated by the reception of ADS PI sentences should be sent to all AIS-LSS as well as to the ASM.
- 3 The status of the AIS fixed stations reported by the ALR PI sentences from each fixed station should be sent to all AIS-LSS as well as to the ASM.
- 4 The status of the communications between each AIS fixed stations and other AIS stations can be derived from examination of the VDM and VSI sentences. These sentences should be sent to the ASM for statistics and trend discovery.
- 5 The status of the AIS-PCU(s) reported by appropriate MDEF sentences.
- 6 The status of the AIS-LSS(s) reported by appropriate MDEF sentences.
- 7 The acknowledgement of alarms by the technical personnel using the ASM. The acknowledgement of AIS fixed station alarms will be forwarded to the appropriate station by the AIS-PCU using ACK PI sentences.

The VSI, FSR and ADS sentences contain a field with the unique identifier of the AIS fixed station making it easy to identify from which station the report comes from. Such is not the case for the VDM, ALR and ACK sentences, although the sequential message identifier can be used to tie the VDM sentence with the related VSI sentence. Alternative solutions, such as the use of comment blocks, should be considered to associate these sentences with their originating fixed station; or targeted fixed station in the case of the ACK sentence.

It should also be mentioned that the ADS sentence is strongly recommended to determine the availability of the connection to a particular fixed station and detect network failures. Although it might be tempting to use the fixed station's VDO messages, especially in the case of AIS base stations, this should be avoided as there are a number of good reasons why a base station would not be broadcasting, temporarily or permanently.

It is recommended that the frequency at which these sentences and reports are produced be configurable. Care should be taken in configuring these report rates as the same reports and sentences are used for the external BAS AIS\_MON.

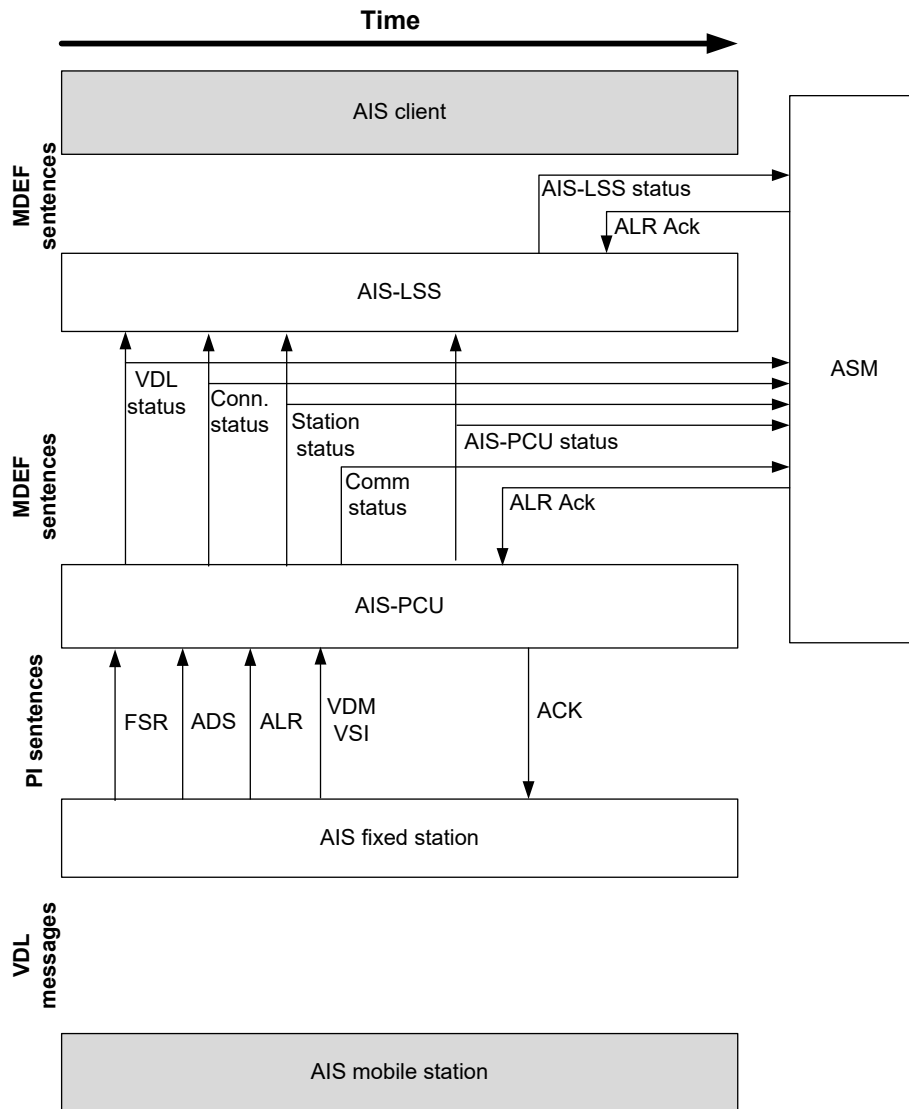

Figure 25 Interaction & data flow model for internal BAS AIS\_MON