

International Dictionary of Marine Aids to Navigation

Alphabetical Index T-Z, - 20 may 2012

Contents

Articles

Tackle	1
Tail chain	1
Tail tube (of a buoy)	1
Tail vane	1
Tank circuit (G.B.)	2
Tank circuit (U.S.A.)	2
Taper charge	2
Tapper	3
Tar	3
Target trail	3
TB cell	4
Telemetry	4
Template	5
Temporary Light	5
Tender	5
Tenderer	5
Tendering procedure	6
Tension	6
Tension-cracked zone	6
Terminal (of a cell or battery)	6
Test boring	7
Test load	7
Test sample	7
Thermal Radiation	7
Thermal Radiator	8
Thermal relay	8
Thermic lance	8
Thermocouple	8
Thermocouple (2)	9
Thermoelectric generator	9
Thermoplastic	9
Thrash (chain)	10
Three-phase alternator	10
Threshold of hearing	10

Threshold of Illuminance	11
Threshold of perception	11
Threshold signal	11
Threshold value (or alert limit)	12
Thrust block	12
Tidal bore	12
Tidal cycle	12
Tidal energy	13
Tidal flat	13
Tidal range	13
Tide	13
Tide-actuated generator	14
Tide - Ebb tide	14
Tide - Flood tide	14
Tide - Half-tide	14
Tide - High tide	15
Tide - Low tide	15
Tide - Neap tides	15
Tide - Spring tides	16
Tide gauge	16
Tide Signals	16
Tie	17
Tile	17
Timber	17
Timbre	17
Time delay switch	18
Time division multiplex (TDM)	18
Time switch	18
Time Switch	19
Time switch (2)	19
Time to alarm	19
Tin	19
Tip speed ratio	20
Topmark	20
Topmark (2)	20
Topping lift	22
Top loaded antenna	22
Toran	22

Toran chain	23
Toran chart	23
Toran Compensating receiver	23
Toran Confocal emitters	24
Toran couple	24
Toran Reference transmitter	24
Torque	25
Totally enclosed enclosure (or machine)	25
Total amplitude of oscillation	25
Total earthing resistance	26
Total loss	26
Total polarization error	26
Total System Error (TSE)	27
Tower (of a wind-power generator)	27
Tower crane	27
Tower rock light	27
Towing	28
Towing winch	28
To bend	28
To bolt	29
To braze	29
To level (surveying)	29
To level off	29
To pour (concrete)	30
To rivet	30
To solder	30
To strike (formwork)	30
To strike off	31
To weld	31
Trailing edge	31
Transfer function	31
Transformation of electric energy	32
Transformer	32
Transient deviation	32
Transition Mark (or Buoy)	33
Transmission	33
Transmission bridge	33
Transmission of electric energy	34

Transmission schedule	34
Transmissivity	34
Transmissometer	35
Transmittance	35
Transmitter load	36
Transmitter power gain	36
Transponder	36
Transponder dead time	37
Transponder reply efficiency	37
Tremie hopper	37
Trench sheeting	38
Trestle	38
Triad	38
Triangle of error	38
Trichromatic System	39
Trickle charge	39
Trigatron	39
Triggered spark-gap	40
Triggering	40
Trigger level	40
Trimming	40
Tristimulus Values	41
Troland	41
Troposphere	42
Tropospheric radio duct	42
Tropospheric wave	42
Trough (of a wave)	43
True motion display	43
True position	43
Truss (of a roof)	43
TR cavity	44
TR cell	44
TR switch	44
TR switch and beam switching combined	45
Tsunami	45
Tube	45
Tubular Discharge Lamp	46
Tubular Lamp	46

Tuned antenna	46
Tungsten-Halogen Lamp	47
Turbulence	47
Two-motion selector	47
Two-step relay	48
Two-stroke engine	48
Two-wire repeater	49
Two buoys mored abreast in a channel	49
Two buoys mored not abreast in a channel	50
Types of service	50
Type DM Raydist	51
Type E Raydist	51
Type M Raydist	52
Type N Raydist	52
T antenna	53
Ultrasonic test	53
Umbrella antenna	53
Undercutting (of cliffs)	53
Underground (power) cable	54
Undisturbed soil sample	54
Uniformly distributed load	54
Uniform Diffuser	54
Uninterrupted duty	55
Unipole antenna	55
Universal motor	55
Unlighted Buoy	56
Unwatched Light	56
Updating/Refresher Training	56
Upright	57
Useful Life (of a lamp)	57
Usual range of a sound signal	57
Utilisation factor	58
Utilisation of energy	58
Vacuum Lamp	58
Valve (of an internal combustion engine)	58
Vaporiser	59
Variable-pitch blade	59
Variable auto-transformer	60

Velodyne integrator	60
Ventilator (passive)	60
Ventilator (powered)	61
Vent plug	61
Vertex plate	61
Vertically polarized wave	62
Vertical antenna	62
Vertical beam width	62
Vessel Technical Error (VTE)	62
Vessel Traffic Management	63
Vessel Traffic Service	63
Vestigial sideband	63
Vibration	64
Vibration (2)	64
Vibrator	64
Vibratory pile driving	64
Video mapping	65
Viscosity	65
Visibility	65
Visibility meter	66
Vision	66
Visual Photometer	66
Visual Range	67
Void ratio	67
Voltage (sensitive) relay	67
Voltage stabiliser	68
Voltage standing-wave ratio	68
Volume velocity	68
Volute of a siren	69
VTSO Position	69
VTS area	69
VTS authority	69
VTS centre	70
VTS Certification Log	70
VTS Manager	70
VTS Operator	70
VTS Operator Certificate	71
VTS Operator Course Certificate	71

VTS Personnel	71
VTS Sailing Plan (VTS Route Plan)	72
VTS services	72
VTS Supervisor	72
VTS Supervisor Course Certificate	73
VTS traffic image	73
Waling	73
Wankel engine	73
Warble tone	74
Warping end (GB)	74
Wash primer	74
Watch buoy	75
Watch Buoy (2)	75
Water-cooled engine	75
Water-jet protected enclosure (or machine)	76
Waterbar	76
Watertight	76
Water and oil separator	76
Water jetting	77
Water level	77
Watt-hour meter	77
Wave	77
Wave-actuated generator	78
Wave-train	78
Waveguide	78
Wavelength	79
Wavelength (2)	79
Wave (2)	79
Wave antenna	80
Wave energy	80
Wave front	80
Wave height	81
Wave interference error	81
Wave load	81
Wave number	82
Wave reflection	82
Wave surface	82
Wave tilt	83

Wear-out-failure period	83
Weather-protected enclosure (or machine)	84
Web (of a girder)	84
Weight tube	84
Well-strobe marker	84
Wet Dock	85
Whip	85
Whip antenna	85
Whistle	86
Whistle buoy	86
Whistle Buoy (2)	86
White	87
Wick	88
Wide aperture direction finder	88
Wide aperture Doppler direction finder	89
Winch	89
Wind-power generator	89
Wind-vane	90
Windlass	90
Wind bracing	90
Wind energy	91
Wind energy conversion system	91
Wind load	91
Wind shear	91
Wind speed duration curve	92
Winter buoy	92
Winter Buoy (U.S.A.)	92
Winter Light (U.S.A.)	93
Wire rope	93
Withdrawal	93
Workability	93
Work barge	94
World-Wide Radio Navigation System	94
World geodetic system (WGS)	94
Worst case	95
Wreck	95
Wreck Mark (or Buoy)	95
Wrought iron	96

X-ray test	96
Yagi antenna	96
Yaw	97
Zenith	97
Zinc	97
Zinc chromate primer	98

References

Article Sources and Contributors	99
Image Sources, Licenses and Contributors	106

Tackle

8-3-030

An assembly of blocks and ropes for obtaining a mechanical advantage when hoisting and lowering weights.

Please note that this is the term as it stands in the original IALA Dictionary edition (1970-1989)

Tail chain

8-5-090

Part of the mooring chain of a buoy or Lanby, connected to a mooring lug at the bottom of the buoy or brought out through the tail tube.

Please note that this is the term as it stands in the original IALA Dictionary edition (1970-1989)

Tail tube (of a buoy)

8-4-140

A central tube below the body of the buoy.

Please note that this is the term as it stands in the original IALA Dictionary edition (1970-1989)

Tail vane

6-3-205

A device of rigid construction, sometimes a flat plate, which is attached at the rear of the movable body of a wind-power generator as the means of making the wind turn the rotor into the wind.

Please note that this is the term as it stands in the original IALA Dictionary edition (1970-1989)

Tank circuit (G.B.)

4-1-630

Tank circuit (G.B.)

The tuned circuit in the anode circuit of the final stage of a transmitter which supplies the radio-frequency energy to the antenna or antenna feeder.

Reference: B.S. (modified)

Please note that this is the term as it stands in the original IALA Dictionary edition (1970-1989)

Tank circuit (U.S.A.)

4-1-635

A circuit capable of storing electrical energy over a band of frequencies continuously distributed about a single frequency at which the circuit is said to be resonant or tuned.

Reference: I.R.E. (modified)

Please note that this is the term as it stands in the original IALA Dictionary edition (1970-1989)

Taper charge

6-5-250

A process whereby the rate of charging is reduced as the battery approaches its fully charged state.

Please note that this is the term as it stands in the original IALA Dictionary edition (1970-1989)

Tapper

3-2-280

Tapper (U.S.A.)

A heavy pendulum suspended outside a bell which sets the bell in vibration by striking it.

Note: A tapper is a form of hammer (3-2-285).

Please note that this is the term as it stands in the original IALA Dictionary edition (1970-1989)

Tar

7-3-535

A black viscous liquid manufactured by the destructive distillation of coal.

Please note that this is the term as it stands in the original IALA Dictionary edition (1970-1989)

Target trail

4-3-075

Target tail

The display of diminishing luminance seen to follow a target on a P.P.I. which results from afterglow and the progress of the target between successive scans of the radar.

Please note that this is the term as it stands in the original IALA Dictionary edition (1970-1989)

TB cell

4-3-200

Alternative term: ATR tube

A gas filled switching tube employed when a common transmitter and receiver antenna is used which automatically decouples the transmitter during the intervals for pulse reception.

Reference: N.T.G. (modified)

Please note that this is the term as it stands in the original IALA Dictionary edition (1970-1989)

Telemetry

5-3-600

Alternative term: Telemetering

Measurement with the aid of intermediate means which permit the measurement to be interpreted at a distance from the primary detector.

Note: 1 The distinctive feature of telemetering is the nature of the translating means, which includes the provisions for converting the quantity to be measured into a representative quantity of another kind that can be transmitted conveniently for measurement at a distance.

Note: 2 In normal French usage "telemetrie" means remote measurement of length.

Reference: I.E.E.E. (modified)

Please note that this is the term as it stands in the original IALA Dictionary edition (1970-1989)

Template

7-6-440

A full-size pattern used to set out any item to be manufactured.

Please note that this is the term as it stands in the original IALA Dictionary edition (1970-1989)

Temporary Light

2-5-070

A light put into service for a limited period (for example, during repair work).

Please note that this is the term as it stands in the original IALA Dictionary edition (1970-1989)

Tender

7-5-405

An offer from a contractor to undertake works detailed in the Contract Documents at a particular price.

Please note that this is the term as it stands in the original IALA Dictionary edition (1970-1989)

Tenderer

7-5-385

A person or company that offers to enter a legal contract as specified in contract documents.

Please note that this is the term as it stands in the original IALA Dictionary edition (1970-1989)

Tendering procedure

7-5-410

The complete process from the issue of Contract Documents to contractors with an invitation to tender to the return, analysis, and acceptance of completed tenders.

Please note that this is the term as it stands in the original IALA Dictionary edition (1970-1989)

Tension

7-5-030

A force applied to a member along its longitudinal axis which tends to elongate that member.

Please note that this is the term as it stands in the original IALA Dictionary edition (1970-1989)

Tension-cracked zone

7-5-350

That part of a tension zone adjacent to the extreme fibres where excessive tension has caused fine cracking of the concrete.

Please note that this is the term as it stands in the original IALA Dictionary edition (1970-1989)

Terminal (of a cell or battery)

6-5-190

A part of a cell or battery to which an external circuit is connected.

Note: It is international practice to mark the positive terminal with a plus sign or the colour red.

Please note that this is the term as it stands in the original IALA Dictionary edition (1970-1989)

Test boring

7-4-330

Drilling into the ground to determine the composition and condition of the subsoil.

Please note that this is the term as it stands in the original IALA Dictionary edition (1970-1989)

Test load

7-5-090

Any load applied to a structural member or object for the purposes of examining the behaviour of that member or object under particular loading conditions.

Please note that this is the term as it stands in the original IALA Dictionary edition (1970-1989)

Test sample

7-5-365

Any sample of a material taken and prepared in a specified manner for testing to determine some particular property.

Please note that this is the term as it stands in the original IALA Dictionary edition (1970-1989)

Thermal Radiation

2-1-510

Process of emission in which the radiant energy originates in the thermal agitation of the particles of matter (atoms, molecules, ions).

Note: The terms "thermal radiation" and, in German Temperaturstrahlung apply not only to the process of emission, but also to the radiation itself.

Reference: C.I.E.

Please note that this is the term as it stands in the original IALA Dictionary edition (1970-1989)

Thermal Radiator

2-1-515

A source emitting by thermal radiation.

Reference: C.I.E.

Please note that this is the term as it stands in the original IALA Dictionary edition (1970-1989)

Thermal relay

5-4-195

A relay whose action depends upon the heating effect of a current passing through it.

Reference: I.E.C. (modified)

Please note that this is the term as it stands in the original IALA Dictionary edition (1970-1989)

Thermic lance

7-6-465

A steel tube which is ignited using oxy-acetylene gas, used for boring or cutting concrete.

Please note that this is the term as it stands in the original IALA Dictionary edition (1970-1989)

Thermocouple

5-4-205

A junction of dissimilar conductors arranged in a circuit so that a voltage is developed by the thermoelectric effect when a temperature difference exists between the junction and other parts of the circuit.

Please note that this is the term as it stands in the original IALA Dictionary edition (1970-1989)

Thermocouple (2)

6-3-305

A junction of dissimilar conductors arranged in a circuit so that a voltage is developed by the thermoelectric effect when a temperature difference exists between the junction and other parts of the circuit.

Please note that this is the term as it stands in the original IALA Dictionary edition (1970-1989)

Thermoelectric generator

6-3-300

Acronym: TEG

A device used to convert heat into electric energy. It consists of a battery of thermocouples, i.e. a thermopile.

Please note that this is the term as it stands in the original IALA Dictionary edition (1970-1989)

Thermoplastic

7-3-315

Term applied to plastic materials which soften on heating and harden on cooling with no adverse effects on the properties of the material.

Please note that this is the term as it stands in the original IALA Dictionary edition (1970-1989)

Thrash (chain)

8-5-065

Alternative term: Chafe (chain) (USA)

That part of a mooring chain of a buoy that is constantly rubbing on the sea-bed as the buoy rises and falls.

Please note that this is the term as it stands in the original IALA Dictionary edition (1970-1989)

Three-phase alternator

6-4-200

An alternator for the production of a system of three-phase currents and voltage.

Please note that this is the term as it stands in the original IALA Dictionary edition (1970-1989)

Threshold of hearing

3-1-200

Alternative term: Threshold of audibility

The minimum r.m.s. sound pressure level of a pure sound which excites the sensation of hearing under specified conditions and at a specified frequency.

Note: 1 The term "Threshold of hearing" is also used to denote the level of the least r.m.s. value of the sound pressure of a complex sound which excites the sensation of hearing.

Note: 2 This threshold is usually determined under conditions of negligible ambient noise, but may be determined under other specified conditions.

Reference: C.E.F.

Please note that this is the term as it stands in the original IALA Dictionary edition (1970-1989)

Threshold of Illuminance

2-1-390

Alternative term: Visual Threshold

The weakest illuminance produced at the eye which makes it possible to see a given source against a given background luminance.

Note: The internationally accepted value of the threshold of illuminance for observation of a light at night under typical maritime conditions is $2.10 \cdot 10^{-7}$ lux (0.686 sea-mile candela, 2-1-060). This figure was agreed at the International Technical Conference of Lighthouse Authorities, Paris 1933. In Britain and U.S.A. this value is sometimes approximated by 0.67 sea-mile candela.

Please note that this is the term as it stands in the original IALA Dictionary edition (1970-1989)

Threshold of perception

1-1-450

Alternative term: Threshold of sensation

The lowest value of a stimulus that produces a perception or sensation.

Please note that this is the term as it stands in the original IALA Dictionary edition (1970-1989)

Threshold signal

4-1-135

The smallest signal capable of being detected above the background noise level.

Please note that this is the term as it stands in the original IALA Dictionary edition (1970-1989)

Threshold value (or alert limit)

The maximum allowable error in the measured position – during integrity monitoring – before an alarm is triggered.

Source: Nick Ward, Vicechair, IALA e-Nav Committee, March 2009

Thrust block

7-6-085

A large cast piece of concrete used as a restraint for an applied force.

Please note that this is the term as it stands in the original IALA Dictionary edition (1970-1989)

Tidal bore

7-4-085

(tidal) bore

A fast travelling upriver wave generated in certain tidal conditions in rivers subject to a large tidal range and a rapid narrowing in width.

Please note that this is the term as it stands in the original IALA Dictionary edition (1970-1989)

Tidal cycle

7-4-090

Alternative term: Tidal wave (USA)

Predictable variation in the height of the sea level due to the effects of the moon, and to a lesser extent the sun, influenced by the rotation of the earth.

Note: A rising tide is called a flood tide and a falling tide an ebb tide.

Please note that this is the term as it stands in the original IALA Dictionary edition (1970-1989)

Tidal energy

6-3-290

Energy derived from the tidal motion of the sea.

Please note that this is the term as it stands in the original IALA Dictionary edition (1970-1989)

Tidal flat

7-4-030

Areas, usually in a river estuary, where large flat expanses of the sea or river bed are exposed as the tide falls.

Please note that this is the term as it stands in the original IALA Dictionary edition (1970-1989)

Tidal range

1-3-035

Alternative term: Tidal amplitude

Difference between the heights of the sea at high tide and the following low tide, or at low tide and the following high tide.

Please note that this is the term as it stands in the original IALA Dictionary edition (1970-1989)

Tide

1-3-005

Periodic rise and fall of the surface of parts of the sea, principally due to the gravitational attraction of the moon and the sun.

Please note that this is the term as it stands in the original IALA Dictionary edition (1970-1989)

Tide-actuated generator

6-3-295

A generator that produces electric energy from the motion of the tidal current.

Note: Such generators may be actuated by the pressure of a head of water built up behind a barrage, or by direct conversion of the energy of tidal flow. In the latter case, the term tidal stream rotor is also used.

Please note that this is the term as it stands in the original IALA Dictionary edition (1970-1989)

Tide - Ebb tide

1-3-010

Falling water of a tide.

Please note that this is the term as it stands in the original IALA Dictionary edition (1970-1989)

Tide - Flood tide

1-3-015

Rising water of a tide.

Please note that this is the term as it stands in the original IALA Dictionary edition (1970-1989)

Tide - Half-tide

1-3-030

Height of the sea halfway between high tide and low tide.

Please note that this is the term as it stands in the original IALA Dictionary edition (1970-1989)

Tide - High tide

1-3-025

Alternative term: High water

Highest water between two successive tides at the point of transition from rising tide to falling tide.

Please note that this is the term as it stands in the original IALA Dictionary edition (1970-1989)

Tide - Low tide

1-3-020

Alternative term: Low water

Lowest water between two successive tides at the point of transition from falling tide to rising tide.

Please note that this is the term as it stands in the original IALA Dictionary edition (1970-1989)

Tide - Neap tides

1-3-045

Alternative term: Neaps

Tides that occur near the times of the first or last quarter of the moon, resulting in a reduction of the tidal range.

Please note that this is the term as it stands in the original IALA Dictionary edition (1970-1989)

Tide - Spring tides

1-3-050

Alternative term: Springs

Tides that occur near the times of full moon and new moon, resulting in an increase of the tidal range.

Please note that this is the term as it stands in the original IALA Dictionary edition (1970-1989)

Tide gauge

7-2-650

An indicator to show the state and range of the tide at a given locality.

Please note that this is the term as it stands in the original IALA Dictionary edition (1970-1989)

Tide Signals

2-6-160

Signals showing to navigators the state or change of the tide according to a prearranged code, or by direct display on a scale.

Note: The German term Wasserstandanzeiger is also used for similar signals in non-tidal waters.

Please note that this is the term as it stands in the original IALA Dictionary edition (1970-1989)

Tie

7-2-150

A structural member designed to resist tension.

Please note that this is the term as it stands in the original IALA Dictionary edition (1970-1989)

Tile

7-3-145

Thin plate of burnt clay used for roof covering.

Note: The term is extended to similar plates of concrete, metal or asbestos-cement.

Please note that this is the term as it stands in the original IALA Dictionary edition (1970-1989)

Timber

7-3-345

Wood prepared for use in building.

Please note that this is the term as it stands in the original IALA Dictionary edition (1970-1989)

Timbre

3-1-175

That subjective quality of a sound which enables a listener to judge that two sounds having the same loudness and pitch are dissimilar.

Reference: B.S.

Please note that this is the term as it stands in the original IALA Dictionary edition (1970-1989)

Time delay switch

6-8-210

An electric device that closes contacts in one circuit at a predetermined time after the closure of contacts in another circuit.

Please note that this is the term as it stands in the original IALA Dictionary edition (1970-1989)

Time division multiplex (TDM)

5-3-100

Alternative term: Time sharing

A device or process for the transmission of two or more signals over a common path by using successive time intervals for the different signals.

Reference: I.R.E.

Please note that this is the term as it stands in the original IALA Dictionary edition (1970-1989)

Time switch

1-1-420

A timing device for switching apparatus on or off at predetermined times.

Please note that this is the term as it stands in the original IALA Dictionary edition (1970-1989)

Time Switch

2-4-150

A device for lighting or extinguishing a light at predetermined times, controlled by a timing device.

Please note that this is the term as it stands in the original IALA Dictionary edition (1970-1989)

Time switch (2)

6-8-220

A timing device for opening or closing one or more electric circuits at predetermined times.

Note: A time switch that operates at sunrise and sunset is called a solar switch.

Please note that this is the term as it stands in the original IALA Dictionary edition (1970-1989)

Time to alarm

The time elapsed between the occurrence of a failure in the system and its presentation on the bridge.

Source: Nick Ward, Vicechair, IALA e-Nav Committee, March 2009

Tin

7-3-050

A ductile white metal used in various alloys with other metals, and in soldering.

Please note that this is the term as it stands in the original IALA Dictionary edition (1970-1989)

Tip speed ratio

6-3-175

The linear speed of a blade tip divided by the corresponding wind speed.

Please note that this is the term as it stands in the original IALA Dictionary edition (1970-1989)

Topmark

8-4-095

An object, or pair of objects, of characteristic shape and colour, that is carried on top of a buoy as a means of identification.

Note:

For details of topmarks used in the IALA Maritime Buoyage System, see Chapter 2 (Rev).

Please note that this is the term as it stands in the original IALA Dictionary edition (1970-1989)

Topmark (2)

2-6-255

One or more relatively small objects of characteristic shape or colour (or both), placed on top of a navigation mark (or buoy) to identify it. (Figs. 65 and 66)

Note 1: A topmark may be

- a. Simple
- b. Composite, viz. made up of two or three individual topmarks.

Note 2: The following characteristic apparent shapes of topmarks are internationally recognised for the lateral system of marking (or buoyage):

- Cone
- Can
- Sphere
- Diamond
- St. George's Cross
- "T"
- Broom

A broom topmark has the appearance of a circular broomhead and has two forms "Broom, point upwards" (in German, "mit Besen abwärts") and "Broom, point downwards" (in German, "mit Besen aufwärts").

Note 3: The following characteristic apparent shapes of topmarks are internationally recognised for the cardinal system of marking (or buoyage):

- Two cones, point upwards
- Two cones, point downwards
- Two cones, point to point
- Two cones, base to base

Note 4: Other forms (e.g. St. Andrew's Cross) are used, for example, as landfall marks.

Note 5: In the U.S.A. the word Daymark is often used for a topmark.

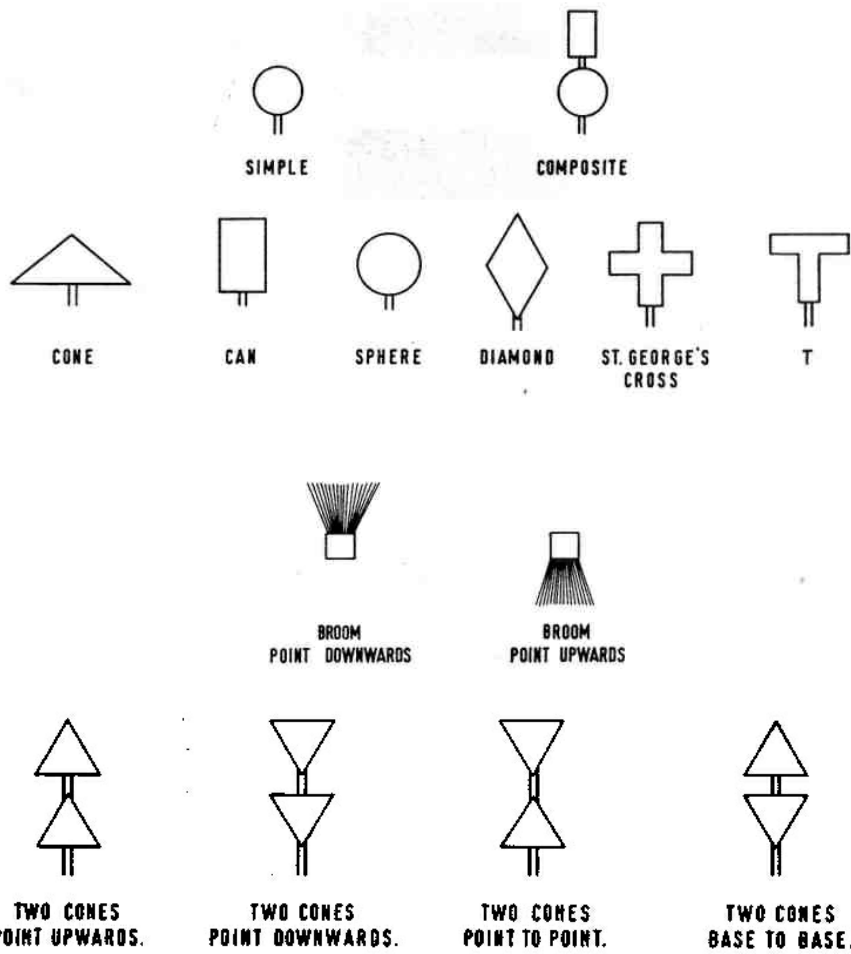

Please note that this is the term as it stands in the original IALA Dictionary edition (1970-1989)

Topping lift

8-3-040

The tackle which takes the weight of a derrick and its load and controls the angle of elevation of the derrick.

Please note that this is the term as it stands in the original IALA Dictionary edition (1970-1989)

Top loaded antenna

4-1-455

A vertical antenna capacitively loaded at its upper end. The loading is often achieved by the attachment of wires or of a metal plate to the top of the antenna.

Please note that this is the term as it stands in the original IALA Dictionary edition (1970-1989)

Toran

4-4-340

A precise system of hyperbolic position fixing in which a mobile station can obtain its position by the determination of the phase differences between the high frequency waves emitted by a pair of confocal transmitters and the transmission from a fixed reference transmitter.

Position fixing is effected by comparing the low frequency beat notes produced by the two confocal transmitters and the modulation note on the fixed transmitter.

The modulation of the fixed transmitter is produced by a fixed compensating receiver, which receives the transmissions from the confocal transmitters and uses the resultant beat note (which includes any instability of frequency and phase of the confocal transmitters) as a means of modulating the fixed transmitter which transmits the phase reference to the mobile receiver.

The operating frequency is in the region of 2 MHz and the maximum range is 300 miles.

Please note that this is the term as it stands in the original IALA Dictionary edition (1970-1989)

Toran chain

4-4-365

A Toran chain comprises at least two couples in order to define the two necessary co-ordinates which are sufficient to obtain a fix.

Please note that this is the term as it stands in the original IALA Dictionary edition (1970-1989)

Toran chart

4-4-370

A chart representing the hyperbolic pattern of a Toran chain.

Topographical receiver (in Toran) 4-4-375

A mobile receiver with indicators, which show the phase of the co-ordinates in order to determine its position.

Please note that this is the term as it stands in the original IALA Dictionary edition (1970-1989)

Toran Compensating receiver

4-4-350

Compensating receiver (in Toran)

A fixed receiver which receives the transmissions of the two confocal transmitters; the low frequency beat note obtained from the output of the receiver constitutes a phase reference.

Please note that this is the term as it stands in the original IALA Dictionary edition (1970-1989)

Toran Confocal emitters

4-4.345

Confocal emitters (in Toran)

Fixed stations generating a hyperbolic pattern. The stations are in no way related or synchronized and transmit unmodulated carriers, the frequencies of which differ by a small amount.

Please note that this is the term as it stands in the original IALA Dictionary edition (1970-1989)

Toran couple

4-4-360

An arrangement comprising two confocal transmitters, a compensating receiver and a reference transmitter.

Please note that this is the term as it stands in the original IALA Dictionary edition (1970-1989)

Toran Reference transmitter

4-4-355

Reference transmitter (in Toran)

A fixed transmitter associated with a compensating receiver and modulated by the low frequency beat frequency output of the receiver, which is used to transmit to the mobile station the phase reference.

Please note that this is the term as it stands in the original IALA Dictionary edition (1970-1989)

Torque

7-5-285

Alternative term: Torsional moment

The twisting moment occurring in a member due to a force applied in the plane of cross section.

Please note that this is the term as it stands in the original IALA Dictionary edition (1970-1989)

Totally enclosed enclosure (or machine)

6-8-265

An enclosure (or machine) designed to prevent the free flow of air to or from the outside, but not to be airtight.

Please note that this is the term as it stands in the original IALA Dictionary edition (1970-1989)

Total amplitude of oscillation

1-1-315

Total amplitude of oscillation (of a periodic quantity)

The difference between the maximum and the minimum value of the quantity during one period.

Note: In the case of sinusoidal oscillation usually called double amplitude.

Reference: I.E.C. (modified)

Please note that this is the term as it stands in the original IALA Dictionary edition (1970-1989)

Total earthing resistance

6-8-110

The electrical resistance between an apparatus or installation and the earth.

Please note that this is the term as it stands in the original IALA Dictionary edition (1970-1989)

Total loss

6-8-090

(total) loss

Alternative term: (total) losses

The difference between the input power and the output power of a device. Note: The loss will usually appear as heat.

Please note that this is the term as it stands in the original IALA Dictionary edition (1970-1989)

Total polarization error

4-2-330

Total polarization error (in bearing)

For a specified direction of incidence and a specified ratio of the amplitudes of the vertically and horizontally polarized components of the incident wave, the maximum value of the polarization error with respect to variation of the phase difference between these components.

Note: The term is applicable only to direction finders designed for operation with either vertically polarized waves or horizontally polarized waves.

Reference: B.S.

Please note that this is the term as it stands in the original IALA Dictionary edition (1970-1989)

Total System Error (TSE)

The overall navigation performance can be described by the TSE. Assuming the contributions to TSE from NSE and VTE are random, the TSE can be described as: $TSE^2 = NSE^2 + VTE^2$

Source: Nick Ward, Vicechair, IALA e-Nav Committee, March 2009

Tower (of a wind-power generator)

6-3-200

The structure that supports the wind-power generator above the ground.

Please note that this is the term as it stands in the original IALA Dictionary edition (1970-1989)

Tower crane

7-6-370

A long horizontal counter-balanced jib mounted on top of a slender tower, used to give total coverage of congested sites with just the one lifting device.

Please note that this is the term as it stands in the original IALA Dictionary edition (1970-1989)

Tower rock light

7-1-025

tower rock station pillar rock light pillar rock station

A station having a light as the principal aid to navigation, founded on an isolated rock pinnacle or group of rocks. In recent years the terms have been extended to offshore structures, founded on the seabed, used to support aids to navigation.

Please note that this is the term as it stands in the original IALA Dictionary edition (1970-1989)

Towing

7-6-270

The action of pulling an object through the water by means of a rope.

Note: In French and in German a distinction is made between remorquage, Schleppen for towing by a vessel and halage, Treideln for towing by a land-based vehicle.

Please note that this is the term as it stands in the original IALA Dictionary edition (1970-1989)

Towing winch

8-3-105

A winch with a large single barrel on which the towing line is reeled. It is usually fitted with an automatic control system that allows the line to run out or heave in according to weather and load conditions while towing.

Please note that this is the term as it stands in the original IALA Dictionary edition (1970-1989)

To bend

7-6-435

Alternative term: To form

To impart a curve or angle as desired into a material.

Please note that this is the term as it stands in the original IALA Dictionary edition (1970-1989)

To bolt

7-6-430

To fasten parts together by means of a bolt.

Please note that this is the term as it stands in the original IALA Dictionary edition (1970-1989)

To braze

7-6-425

To join suitable metals by means of a hard fusible alloy of brass and zinc at a relatively high temperature.

Please note that this is the term as it stands in the original IALA Dictionary edition (1970-1989)

To level (surveying)

7-6-530

To determine differences in altitude using an optical instrument and a calibrated levelling staff.

Please note that this is the term as it stands in the original IALA Dictionary edition (1970-1989)

To level off

7-6-055

To smooth off and bring to approximately level a wet concrete surface.

Please note that this is the term as it stands in the original IALA Dictionary edition (1970-1989)

To pour (concrete)

7-6-020

To transfer freshly mixed concrete into shuttering or a mould.

Please note that this is the term as it stands in the original IALA Dictionary edition (1970-1989)

To rivet

7-6-445

To join together metal parts using rivets (see 7-2-355).

Please note that this is the term as it stands in the original IALA Dictionary edition (1970-1989)

To solder

7-6-450

Alternative term: To sweat

To join together items of copper, brass or lead using a soft lead-tin alloy which is melted at a relatively low temperature at the join, then hardens and bonds forming a connection.

Please note that this is the term as it stands in the original IALA Dictionary edition (1970-1989)

To strike (formwork)

7-6-105

Removal of formwork from set concrete.

Please note that this is the term as it stands in the original IALA Dictionary edition (1970-1989)

To strike off

7-6-060

To level off the free surface of concrete contained in shuttering by passing a board across the surface, supported each side by the top edge of the shuttering.

Please note that this is the term as it stands in the original IALA Dictionary edition (1970-1989)

To weld

7-6-455

The joining of two materials of similar composition by fusion.

Please note that this is the term as it stands in the original IALA Dictionary edition (1970-1989)

Trailing edge

6-3-145

That part of a blade that is the last to contact the air flow during normal operation.

Please note that this is the term as it stands in the original IALA Dictionary edition (1970-1989)

Transfer function

5-2-205

A mathematical expression giving the complex ratio of the output variable to the input variable of a control element (or system).

Reference: I.E.C. (modified)

Please note that this is the term as it stands in the original IALA Dictionary edition (1970-1989)

Transformation of electric energy

6-7-005

Conversion of electric energy without change of the fundamental frequency.

Please note that this is the term as it stands in the original IALA Dictionary edition (1970-1989)

Transformer

6-7-015

A device for the transformation of electric energy.

Note: The terms step-up transformer and step-down transformer refer respectively to a transformer that is used to increase or decrease the voltage.

Please note that this is the term as it stands in the original IALA Dictionary edition (1970-1989)

Transient deviation

5-2-195

The instantaneous value of the ultimately controlled variable minus its steady state value.

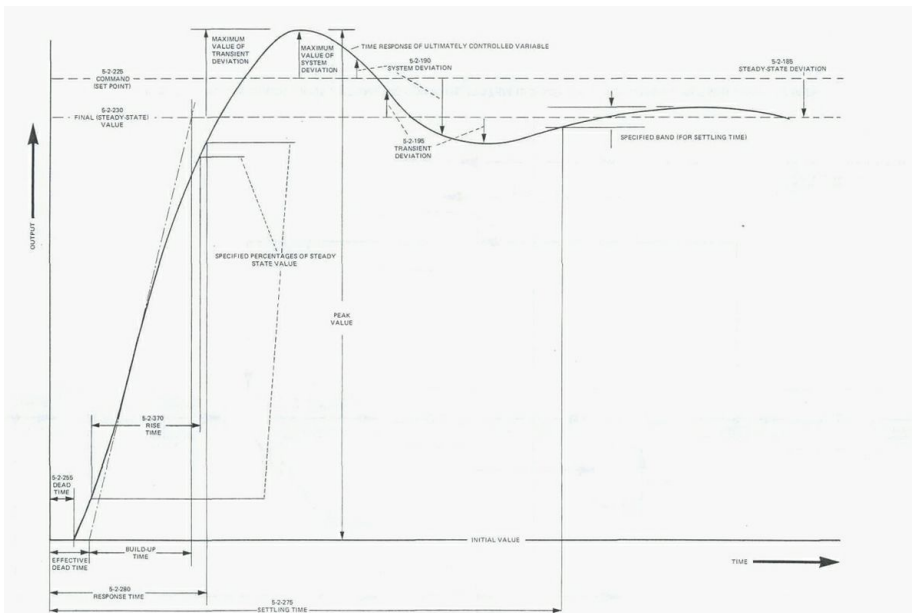

Figure 3 - Typical time response of a system to a step increase of input.

Reference: ANSI

Please note that this is the term as it stands in the original IALA Dictionary edition (1970-1989)

Transition Mark (or Buoy)

2-6-110

A mark (or buoy) indicating the transition between the lateral and cardinal systems of marking or buoyage.

Please note that this is the term as it stands in the original IALA Dictionary edition (1970-1989)

Transmission

1-1-190

Passage of radiation through a medium without change of frequency of the monochromatic components of which the radiation is composed.

Reference: C.I.E.

Please note that this is the term as it stands in the original IALA Dictionary edition (1970-1989)

Transmission bridge

5-4-280

In telephony, a device primarily intended to permit the through transmission of audio frequency currents whilst preventing the through transmission of d.c. signals.

Note: The bridge may have other functions such as the control of the holding, supervision and release of a connection. It may also feed microphone current to the telephone instrument.

Reference: I.E.C.

Please note that this is the term as it stands in the original IALA Dictionary edition (1970-1989)

Transmission of electric energy

6-6-000

The conveying of electric energy from one place to another, by way of a line or cable.

Please note that this is the term as it stands in the original IALA Dictionary edition (1970-1989)

Transmission schedule

4-2-015

Radio beacon schedule Sequence number

A term used in parts of the world where radio beacons are operated in groups. It indicates the position (or positions) in the group occupied by the transmissions of the radio beacon and is designated by the numbers) of the minute(s) in which transmission occurs.

Reference: A.L.R.S.

Please note that this is the term as it stands in the original IALA Dictionary edition (1970-1989)

Transmissivity

2-1-195

Transmissivity (of an absorbing material)

The internal transmittance of a layer of the material such that the path of the radiation is of Unit: length, and under conditions in which the boundary of the material has no influence.

Reference: C.I.E.

Please note that this is the term as it stands in the original IALA Dictionary edition (1970-1989)

Transmissometer

5-4-365

A device which assesses the visibility by measurement of the attenuation of radiation along a straight path through the atmosphere, resulting from the presence of particles which cause scattering and absorption of radiation out of the path. In a homogenous atmosphere, the attenuation can be directly related to the atmospheric transmission factor (2-1-270).

Please note that this is the term as it stands in the original IALA Dictionary edition (1970-1989)

Transmittance

2-1-185

Alternative term: Transmission Factor

The ratio of the transmitted luminous flux (Ft) to the incident flux (Fo).

Symbol: T

Note: Where mixed transmission occurs, the (total) transmittance may be divided into two parts, Regular Transmittance (T_r) and Diffuse Transmittance (T_d), corresponding respectively to the two modes of transmission referred to in 2-1-170 and 2-1-175.

$$T = T_r + T_d$$

Reference: C.I.E. (modified)

Please note that this is the term as it stands in the original IALA Dictionary edition (1970-1989)

Transmitter load

4-1-665

Load (of a radio transmitter)

Output load (of a radio transmitter)

The output termination into which the radio energy from the transmitter flows.

Note: This may be an antenna, a feeder system, or, for test purposes, an artificial antenna.

Please note that this is the term as it stands in the original IALA Dictionary edition (1970-1989)

Transmitter power gain

4-1-660

Power gain (of a radio transmitter)

The ratio of the output power delivered to a specified load by an amplifier to the power absorbed by its input circuit.

Please note that this is the term as it stands in the original IALA Dictionary edition (1970-1989)

Transponder

4-3-420

Alternative term: Transponder beacon

A component of a secondary radar system which receives pulses from a radar set or interrogator, and, in response to the received pulse, transmits a pulse or sequence of pulses to enable the craft or beacon incorporating the transponder to be identified by the interrogating station.

Step Sweet zacon Bacure eada a Ralaysafe fas a fas

Please note that this is the term as it stands in the original IALA Dictionary edition (1970-1989)

Transponder dead time

4-3-470

Dead time (of a transponder)

The minimum interval of time following an interrogating pulse during which a transponder is incapable of further response.

Please note that this is the term as it stands in the original IALA Dictionary edition (1970-1989)

Transponder reply efficiency

4-3-465

The ratio of the number of responses emitted by a transponder to the number of valid interrogations received.

Please note that this is the term as it stands in the original IALA Dictionary edition (1970-1989)

Tremie hopper

7-6-400

The upper part of a system used to place concrete underwater without segregation.

Note: The lowest part of the hopper connects to a tremie pipe or spout leading beneath the water to the desired location. The complete system is called a tremie.

Please note that this is the term as it stands in the original IALA Dictionary edition (1970-1989)

Trench sheeting

7-6-225

Light interlocked steel sheeting driven vertically into the ground to retain the walls of an excavation.

Please note that this is the term as it stands in the original IALA Dictionary edition (1970-1989)

Trestle

7-2-255

A framework of timber or steel used to support a structure such as a bridge deck, for example temporarily during construction.

Please note that this is the term as it stands in the original IALA Dictionary edition (1970-1989)

Triad

4-1-1045

Alternative terms: Triad (in radionavigation), Triplet (in radionavigation)

Three radio stations operated as a group for the determination of positions.

Please note that this is the term as it stands in the original IALA Dictionary edition (1970-1989)

Triangle of error

1-2-080

Alternative term: Cocked hat (G.B.)

Triangle that is formed by three lines of position that do not intersect in one point.

Please note that this is the term as it stands in the original IALA Dictionary edition (1970-1989)

Trichromatic System

2-1-470

Alternative term: Colorimetric System

A system of colour specification based on the possibility of matching a colour stimulus by the additive mixture of three suitably chosen reference stimuli.

Reference: C.I.E.

Please note that this is the term as it stands in the original IALA Dictionary edition (1970-1989)

Trickle charge

6-5-230

A continuous charge at low rate that is intended to compensate for the self discharge of a battery on open circuit and thus to maintain the battery in a fully-charged condition.

Please note that this is the term as it stands in the original IALA Dictionary edition (1970-1989)

Trigatron

4-3-395

A gas filled tube with a spark gap and a trigger electrode by which the discharge is initiated.

Reference: B.S.

Please note that this is the term as it stands in the original IALA Dictionary edition (1970-1989)

Triggered spark-gap

4-3-390

A spark-gap whose breakdown is initiated by a voltage pulse.

Please note that this is the term as it stands in the original IALA Dictionary edition (1970-1989)

Triggering

4-3-455

The process of causing a transponder to reply, for example by interrogation.

Please note that this is the term as it stands in the original IALA Dictionary edition (1970-1989)

Trigger level

4-3-460

Alternative term: Minimum trigger level

The minimum input signal level to the receiver of a transponder which is capable of causing the transmitter to emit a reply.

Please note that this is the term as it stands in the original IALA Dictionary edition (1970-1989)

Trimming

2-3-075

The operation of removing the carbonised part of the wick of an oil lamp.

Note: Trimming is usually effected by the use of curved scissors.

Please note that this is the term as it stands in the original IALA Dictionary edition (1970-1989)

Tristimulus Values

2-1-475

Tristimulus Values (of a colour stimulus)

The amounts of the three reference or matching stimuli required to give a match with the colour stimulus considered, in a given trichromatic system.

Symbol: (Reference: C.I.E. 1931) X, Y, Z.

Reference: C.I.E. (extract)

Note: The quantities X, Y, Z refer to a field of vision of about 2 degrees. In 1964, quantities were defined by the Reference: C.I.E. to refer to a field of vision of about 10 degrees. These are denoted by the symbols X₁₀, Y₁₀, Z₁₀.

Please note that this is the term as it stands in the original IALA Dictionary edition (1970-1989)

Troland

2-1-360

Unit: used for expressing the magnitude of the external light stimulus applied to the eye. When the eye is viewing a surface of uniform luminance, the number of trolands is equal to the product of the area in square millimetres of the limiting pupil, natural or artificial, and the luminance of the surface in candelas per square metre.

Usually, 1 troland produces a retinal illuminance of approximately 2×10^{-3} lumen per square metre.

Reference: C.I.E. (extract)

Note: For the correction factors which must be taken into account in computing the retinal illuminance, see Reference: C.I.E.

Please note that this is the term as it stands in the original IALA Dictionary edition (1970-1989)

Troposphere

4-1-960

The lower part of the earth's atmosphere extending upwards from the earth's surface, in which temperature decreases with height except in local layers of temperature inversion.

Reference: B.S.

Please note that this is the term as it stands in the original IALA Dictionary edition (1970-1989)

Tropospheric radio duct

4-1-1000

A quasi-horizontal layer in the troposphere between the boundaries of which radio energy of a sufficiently high frequency is substantially confined and propagated with abnormally low attenuation.

Reference: C.C.I.R.

Please note that this is the term as it stands in the original IALA Dictionary edition (1970-1989)

Tropospheric wave

4-1-985

A wave which travels between points on or near the surface of the earth by a path or paths lying wholly within the troposphere, and the propagation of which is determined primarily by the distribution of refractive index in the troposphere.

Reference: N.T.G.

Please note that this is the term as it stands in the original IALA Dictionary edition (1970-1989)

Trough (of a wave)

7-4-130

The lowest part of a wave.

Please note that this is the term as it stands in the original IALA Dictionary edition (1970-1989)

True motion display

4-3-135

A display in which own ship's position can appear at any point on the screen. All moving targets appear on the screen with true speeds and directions and all fixed objects as stationary echoes.

Please note that this is the term as it stands in the original IALA Dictionary edition (1970-1989)

True position

(2D). The error-free latitude and longitude co-ordinates in a specified geodetic datum.

(3D). The error-free latitude, longitude and height co-ordinates in a specified geodetic datum.

Source: Nick Ward, Vicechair, IALA e-Nav Committee, March 2009

Truss (of a roof)

7-2-180

A frame of structural members designed to support a roof.

Please note that this is the term as it stands in the original IALA Dictionary edition (1970-1989)

TR cavity

4-3-205

TR cavity (U.S.A.)

The resonant portion of a TR switch.

Reference: I.R.E.

Please note that this is the term as it stands in the original IALA Dictionary edition (1970-1989)

TR cell

4-3-195

Alternative term: TR tube

A gas filled switching tube, employed when a common transmitter and receiver antenna is used which automatically decouples the receiver from the antenna during the transmission period.

Reference: N.T.G. (modified)

Please note that this is the term as it stands in the original IALA Dictionary edition (1970-1989)

TR switch

4-3-190

Alternative term: TR box

A switch, frequently of the gas discharge type, employed when a common transmitting and receiving antenna is used, which automatically decouples the receiver from the antenna during the transmission period.

Reference: I.R.E.

Please note that this is the term as it stands in the original IALA Dictionary edition (1970-1989)

TR switch and beam switching combined

4-3-400

No English term

In radar, a system which combines the functions of a TR switch and beam switching.

Please note that this is the term as it stands in the original IALA Dictionary edition (1970-1989)

Tsunami

7-4-095

Alternative term: Tidal wave (GB)

A single large wave or series of waves caused by earthquakes, landslides, or volcanic effects, usually submarine in nature.

Please note that this is the term as it stands in the original IALA Dictionary edition (1970-1989)

Tube

7-2-230

A structural member in the form of a long hollow thin walled cylinder.

Please note that this is the term as it stands in the original IALA Dictionary edition (1970-1989)

Tubular Discharge Lamp

2-3-335

A discharge lamp of tubular form either straight or curved.

Note: In German usage, such a discharge lamp is called Leuchtroehre if it contains no luminescent material and operates at high voltage (up to about 6,000 volts).

Reference: C.I.E.

Please note that this is the term as it stands in the original IALA Dictionary edition (1970-1989)

Tubular Lamp

2-3-170

An incandescent lamp with a tubular bulb, having the filament mounted along the axis of the tube.

Reference: C.I.E. (extract)

Please note that this is the term as it stands in the original IALA Dictionary edition (1970-1989)

Tuned antenna

4-1-245

An antenna which, together with its appropriate tuning circuit, resonates at a desired frequency.

Reference: B.S. (modified)

Please note that this is the term as it stands in the original IALA Dictionary edition (1970-1989)

Tungsten-Halogen Lamp

2-3-160

An incandescent lamp with a gas filling to which a certain proportion of a halogen has been added in order to minimise blackening of the envelope by returning evaporated tungsten to the filament.

It is usually characterised by exceptionally small size in relation to the high luminous intensities which can be obtained.

Note: The Tungsten-Iodine Lamp or Quartz-Iodine Lamp belongs to this category.

Please note that this is the term as it stands in the original IALA Dictionary edition (1970-1989)

Turbulence

6-3-120

Disorderly air flow produced by obstructions (buildings, trees, etc) in the path of wind, or by the increase in friction when winds pass over the coast from sea to land.

Please note that this is the term as it stands in the original IALA Dictionary edition (1970-1989)

Two-motion selector

5-4-275

Alternative term: Strowger selector

An electromechanical selector having two motions the first vertical, and the second rotary.

Reference: I.E.C.

Please note that this is the term as it stands in the original IALA Dictionary edition (1970-1989)

Two-step relay

5-4-180

A relay with two groups of contact springs, one group only of which is operated by a specified magnetic flux and both groups by a greater magnetic flux.

Reference: I.E.C. (modified)

Please note that this is the term as it stands in the original IALA Dictionary edition (1970-1989)

Two-stroke engine

6-2-045

An internal combustion engine in which the working cycle is completed in two strokes of the piston (i.e. in one revolution of the crankshaft).

Note: 1 The downstroke of the piston corresponds to

- fuel injection, combustion and the beginning of exhaust in diesel engines
- explosion and exhaust in petrol engines

Note: 2 The upstroke of the piston corresponds to

- intake of air and compression in diesel engines
- admission of mixture and compression in petrol engines

Please note that this is the term as it stands in the original IALA Dictionary edition (1970-1989)

Two-wire repeater

5-4-245

A repeater which provides for transmission in both directions over a two-wire or two-wire type circuit.

Reference: I.E.C.

Please note that this is the term as it stands in the original IALA Dictionary edition (1970-1989)

Two buoys moored abreast in a channel

2-6-140

No English Term (2009: Gate)

Term used of two buoys, one to port, the other to starboard, moored abreast in a channel.

(Fig. 55a)

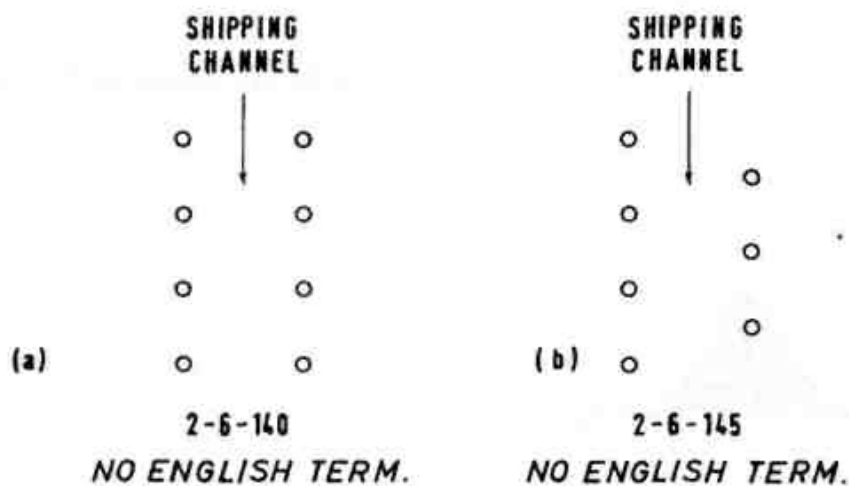

Please note that this is the term as it stands in the original IALA Dictionary edition (1970-1989)

Two buoys moored not abreast in a channel

2-6-145

No English Term (2009: Staggered buoys)

Term applied to buoys moored on either hand of the path of shipping in a channel, such that port hand and starboard hand buoys are not abreast but occur alternately at nearly equal intervals of distance. (Fig. 55b)

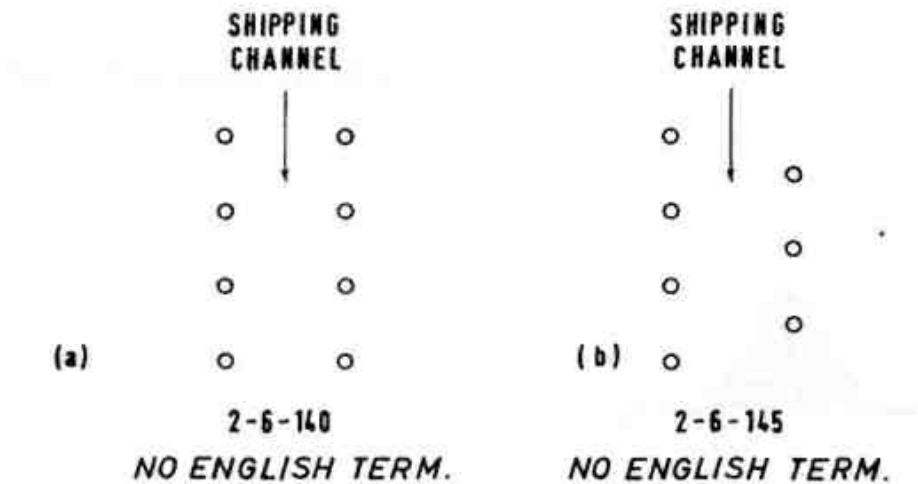

Please note that this is the term as it stands in the original IALA Dictionary edition (1970-1989)

Types of service

4-2-025

1. Beacon service

A service provided independently of weather conditions, the station transmitting signals at certain fixed times daily or continuously.

Reference: A.L.R.S. (modified)

2. Clear weather transmission

Signals transmitted during clear weather by a station whose service is extended during periods of fog or low visibility.

3. Fog service

The service provided by a radio beacon as an aid to navigation during periods of fog or low visibility.

4. Calibration service

A service provided for the purpose of calibration of direction finders.

Reference: A.L.R.S. (modified)

Please note that this is the term as it stands in the original IALA Dictionary edition (1970-1989)

Type DM Raydist

4-4-285

A Raydist distance measuring system using circular co-ordinates, capable of producing a position fix to greater precision than that obtained with the hyperbolic system.

Two transmitters are used, one on the ship and one on the shore.

One frequency is nearly twice the other, so that the shore station can receive the signal from the vessel without interference.

This station doubles the lower frequency and compares it with the higher.

The resultant beat note is transmitted to the ship via a radio link. A second shore station likewise treats the two frequencies and transmits the resultant beat note via a radio link.

The vessel then compares these two beat notes with that similarly generated locally, enabling the distance to each shore station to be obtained.

Saturation is alleviated by having other vessels using different offset frequencies.

Please note that this is the term as it stands in the original IALA Dictionary edition (1970-1989)

Type E Raydist

4-4-290

A ranging system similar to the basic leg of DM Raydist used in ship speed trials, and ocean current studies.

Please note that this is the term as it stands in the original IALA Dictionary edition (1970-1989)

Type M Raydist

4-4-275

A hyperbolic co-ordinate Raydist system which uses a single reference transmitter ashore, a transmitter on the vessel, whose frequency is offset by a few hundred cycles from that of the reference transmitter, and nominally three receivers, suitably spaced from each other, ashore.

The audio heterodyne frequency produced is transmitted via cable or radio link from each receiver to a common location, where it is phase compared.

The position information derived from the two hyperbolae is transmitted to the vessel by radio link.

The system is limited to one vessel for each pair of radio frequencies employed.

Please note that this is the term as it stands in the original IALA Dictionary edition (1970-1989)

Type N Raydist

4-4-280

A hyperbolic co-ordinate Raydist system.

Three shore transmitters operate at radio frequencies very close to each other.

A fourth, or relay, station receives these transmissions and from them produces two audio beat tones. These are re-transmitted by this station on a different radio frequency.

The vessel receives the transmissions from all four stations in a dual frequency receiver.

This produces two similar beat notes from the three main transmitters as the relay station, and these are phase compared with the beat notes from the relay station, to produce hyperbolic lines.

The system is non-saturable as it requires no transmission from the vessel.

Please note that this is the term as it stands in the original IALA Dictionary edition (1970-1989)

T antenna

4-1-465

An antenna comprising one or more horizontal parallel conductors insulated at their ends and connected at their mid point(s) to the down lead.

Please note that this is the term as it stands in the original IALA Dictionary edition (1970-1989)

Ultrasonic test

7-6-510

Test used to detect flaws and defects in materials and welds using ultra high frequency sound.

Please note that this is the term as it stands in the original IALA Dictionary edition (1970-1989)

Umbrella antenna

4-1-475

An antenna consisting of conductors in successive positions of the generator of a vertical cone; the upper ends, which are at the apex of the cone, are connected to a down lead which is often the supporting tower.

Please note that this is the term as it stands in the original IALA Dictionary edition (1970-1989)

Undercutting (of cliffs)

7-4-280

Wave action at the base of cliffs removing material leaving the upper part overhanging, eventually leading to collapse.

Please note that this is the term as it stands in the original IALA Dictionary edition (1970-1989)

Underground (power) cable

6-6-070

A power cable buried in the ground.

Please note that this is the term as it stands in the original IALA Dictionary edition (1970-1989)

Undisturbed soil sample

7-4-310

Sample of soil taken from the mass carefully removed and immediately sealed to prevent moisture changes.

Please note that this is the term as it stands in the original IALA Dictionary edition (1970-1989)

Uniformly distributed load

7-5-080

Acronym: UDL

A load which is evenly spread across the length and width of that part of a structural member under consideration.

Please note that this is the term as it stands in the original IALA Dictionary edition (1970-1989)

Uniform Diffuser

2-1-225

A diffuser for which the luminance is the same in all directions irrespective of the direction of incidence of the light.

Transmission $L = E T/p$

Reflection $L = E p/p$

Reference: C.I.E. (modified)

Please note that this is the term as it stands in the original IALA Dictionary edition (1970-1989)

Uninterrupted duty

6-4-110

Duty with variable loads but with no interval of rest.

Note: Sometimes also referred to as continuously-running duty.

Please note that this is the term as it stands in the original IALA Dictionary edition (1970-1989)

Unipole antenna

4-1-430

Monopole antenna

An open antenna acting as one part of a dipole whose other part is represented by its electrical image in the earth or an effective ground plane. In current usage the term is generally restricted to a straight antenna about a quarter-wave long and fed at the end nearer the

Please note that this is the term as it stands in the original IALA Dictionary edition (1970-1989)

Universal motor

6-4-235

Alternative term: a.c./d.c. motor

An electric motor designed to be operated by either single-phase alternating current or direct current.

Please note that this is the term as it stands in the original IALA Dictionary edition (1970-1989)

Unlighted Buoy

2-6-175

A buoy not fitted with a light.

Please note that this is the term as it stands in the original IALA Dictionary edition (1970-1989)

Unwatched Light

2-5-030

Alternative term: Unmanned Light (U.S.A.)

A light which is operated automatically and may be maintained in service automatically for extended periods of time, but with routine visits for maintenance purposes.

Please note that this is the term as it stands in the original IALA Dictionary edition (1970-1989)

Updating/Refresher Training

Training required by the Competent and/or VTS Authority in order to ensure that the level of competence is maintained appropriate to the service type(s) provided by the particular VTS centre when, for example, there has been a break in service, new equipment installed or new operating procedures have been introduced.

Source: IALA VTS Manual

Upright

7-2-215

Any vertical or nearly vertical member.

Please note that this is the term as it stands in the original IALA Dictionary edition (1970-1989)

Useful Life (of a lamp)

2-3-445

The length of time during which the luminous flux emitted by the lamp exceeds a specified proportion of its initial value.

Please note that this is the term as it stands in the original IALA Dictionary edition (1970-1989)

Usual range of a sound signal

3-1-255

The distance at which, in foggy weather, an observer has a 50% probability of hearing a sound signal when he is situated on the wing of a ship's bridge in an ambient noise level (as defined by the I.A.L.A. sub-committee on the rated range of sound signals) which is equal to or greater than that found on 50% of large merchant vessels, propagation between the sound signalling apparatus and the observer being effected in relatively calm weather, with no intervening obstacles.

Please note that this is the term as it stands in the original IALA Dictionary edition (1970-1989)

Utilisation factor

6-8-055

The ratio of the total energy delivered by a source in a given interval of time to the total energy available from the source in the same interval of time.

Please note that this is the term as it stands in the original IALA Dictionary edition (1970-1989)

Utilisation of energy

6-8-000

The intentional use of one kind of energy to produce another kind of energy.

Please note that this is the term as it stands in the original IALA Dictionary edition (1970-1989)

Vacuum Lamp

2-3-150

An incandescent lamp in which the luminous element operates in an evacuated bulb.

Reference: C.I.E.

Please note that this is the term as it stands in the original IALA Dictionary edition (1970-1989)

Valve (of an internal combustion engine)

6-2-140

A device used to control the passage of the working fluid into or out of the cylinder.

Please note that this is the term as it stands in the original IALA Dictionary edition (1970-1989)

Vaporiser

2-4-075

Part of the mechanism of a paraffin-vapour lamp in which the paraffin is vaporised and ejected into the burner.

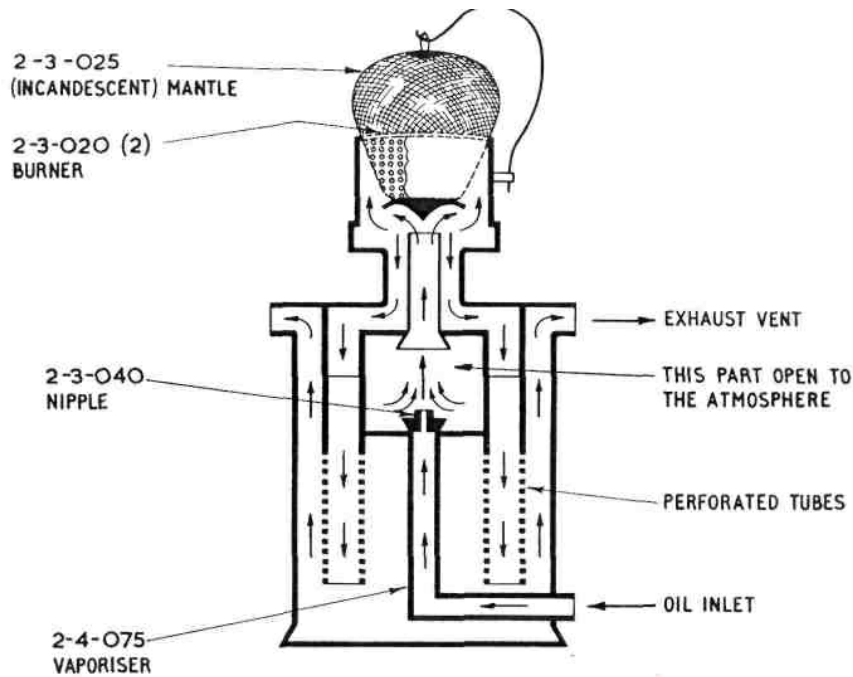

Please note that this is the term as it stands in the original IALA Dictionary edition (1970-1989)

Variable-pitch blade

6-3-155

A blade for which the blade pitch can be varied within limits while the rotor is turning, in order to control the speed of the rotor.

Note: This action is called blade pitch control.

Please note that this is the term as it stands in the original IALA Dictionary edition (1970-1989)

Variable auto-transformer

6-8-170

An auto-transformer in which at least one of the external connections may be moved along the winding to vary the turns ratio and so to control the alternating supply voltage output.

Please note that this is the term as it stands in the original IALA Dictionary edition (1970-1989)

Velodyne integrator

5-4-135

A servo mechanism usually employing a d.c. split field motor and tacho-generator on the same shaft, in which it is intended that the speed of rotation be maintained proportional to an input voltage. The total number of revolutions of the output shaft is an approximate measure of the time-integral of the input voltage.

Reference: B.S.

Please note that this is the term as it stands in the original IALA Dictionary edition (1970-1989)

Ventilator (passive)

7-2-625

A device permitting the entry or exit of air into a room or building.

Please note that this is the term as it stands in the original IALA Dictionary edition (1970-1989)

Ventilator (powered)

7-2-630

Alternative term: Extractor fan

A powered device controlling the flow of air into or out of a room or building.

Please note that this is the term as it stands in the original IALA Dictionary edition (1970-1989)

Vent plug

6-5-200

A part at the top of a secondary cell that allows gas to escape during charging.

Please note that this is the term as it stands in the original IALA Dictionary edition (1970-1989)

Vertex plate

4-1-570

Vertex plate (of a reflector)

A plate placed near the vertex of a reflector to prevent undesired reflection back to the primary radiator.

Reference: B.S.

Please note that this is the term as it stands in the original IALA Dictionary edition (1970-1989)

Vertically polarized wave

4-1-855

A plane polarized wave in which the electric field vector is in a vertical plane.

Please note that this is the term as it stands in the original IALA Dictionary edition (1970-1989)

Vertical antenna

4-1-450

An open antenna arranged so as to receive only the vertically polarized components of the electric field of the received waves.

Reference: B.S.

Please note that this is the term as it stands in the original IALA Dictionary edition (1970-1989)

Vertical beam width

4-1-410

The beam width measured in a vertical plane.

Please note that this is the term as it stands in the original IALA Dictionary edition (1970-1989)

Vessel Technical Error (VTE)

The difference between the indicated craft position and the indicated command or desired position. It is a measure of the accuracy with which the craft is controlled.

Source: Nick Ward, Vicechair, IALA e-Nav Committee, March 2009

Vessel Traffic Management

Vessel Traffic Management is the co-ordination and exchange of data about global maritime activities.

It may incorporate VTS and include information from other maritime agencies.

Source: IALA VTS Manual

Vessel Traffic Service

A service implemented by a Competent Authority, designed to improve the safety and efficiency of vessel traffic and to protect the environment.

The service should have the capability to interact with the traffic and respond to traffic situations developing in the VTS area.

Source: IALA VTS Manual

Vestigial sideband

5-3-175

A sideband in which some of the spectral components, in general those corresponding to the highest frequency in the modulating signals, are greatly attenuated.

Reference: I.E.C.

Please note that this is the term as it stands in the original IALA Dictionary edition (1970-1989)

Vibration

7-4-215

Compaction of a soil by means of a vibrating tool.

Please note that this is the term as it stands in the original IALA Dictionary edition (1970-1989)

Vibration (2)

7-5-420

A rapid oscillatory movement.

Please note that this is the term as it stands in the original IALA Dictionary edition (1970-1989)

Vibrator

7-6-015

A device to vibrate wet concrete in order to eliminate air bubbles and increase compaction.

Please note that this is the term as it stands in the original IALA Dictionary edition (1970-1989)

Vibratory pile driving

7-6-165

The forcing of piles into the ground by means of mechanical vibration applied under steady load.

Please note that this is the term as it stands in the original IALA Dictionary edition (1970-1989)

Video mapping

4-3-150

The electronic superimposing of a map or a plan on a radar display.

Reference: I.C.A.O.

Please note that this is the term as it stands in the original IALA Dictionary edition (1970-1989)

Viscosity

7-5-450

The resistance of a fluid to flowing due to internal friction.

Please note that this is the term as it stands in the original IALA Dictionary edition (1970-1989)

Visibility

2-1-275

1. That property of the atmosphere which determines the ability of an observer to see and identify prominent objects by day, or lights or lighted objects by night.

2. A measure of this property of the atmosphere expressed in units of distance.

3. Commonly used for "meteorological visibility".

Please note that this is the term as it stands in the original IALA Dictionary edition (1970-1989)

Visibility meter

5-4-360

A device which assesses the visibility by measurement of a related function of the properties of the atmosphere.

Please note that this is the term as it stands in the original IALA Dictionary edition (1970-1989)

Vision

2-1-315

Alternative term: Visual Perception

The reception of light by the eye and the evaluation of the information contained in the light.

Please note that this is the term as it stands in the original IALA Dictionary edition (1970-1989)

Visual Photometer

2-1-540

A photometer in which equality between a radiation under test and a comparison radiation is established visually.

The methods chiefly employed are luminosity match of two adjacent surfaces, adjustment to equality of contrast, or adjustment to minimum flicker.

Reference: C.I.E. (modified)

Please note that this is the term as it stands in the original IALA Dictionary edition (1970-1989)

Visual Range

2-1-285

1. The maximum distance (usually horizontal) at which a given object can be seen by day in any particular circumstances, as limited by the atmospheric transmission. The distance is such that the contrast of the object with its background is reduced by the atmosphere to the contrast threshold value for the observer (2-1-300).

2. Loosely used as a synonym for "visibility" (in sense 2 of 2-1 -275). This use of the term is deprecated.

Please note that this is the term as it stands in the original IALA Dictionary edition (1970-1989)

Void ratio

7-4-240

The ratio of the volume of voids in a soil sample to the volume of solids.

Please note that this is the term as it stands in the original IALA Dictionary edition (1970-1989)

Voltage (sensitive) relay

5-4-165

A relay the operation of which depends on the magnitude of the voltage.

Please note that this is the term as it stands in the original IALA Dictionary edition (1970-1989)

Voltage stabiliser

6-7-090

A device that automatically keeps a voltage within specified limits.

Note: The term automatic voltage regulator (AVR) is used for a device that automatically keeps the output voltage of a generator within specified limits.

Please note that this is the term as it stands in the original IALA Dictionary edition (1970-1989)

Voltage standing-wave ratio

4-1-545

Acronym: V.S.W.R.

In a transmission line or waveguide, the ratio of the amplitude of the transverse electric field at a plane of minimum strength to the amplitude at a corresponding point in an adjacent plane of maximum field strength.

Note: In some countries other than Britain, the reciprocal of this ratio is preferred.

Reference: B.S. (modified)

Please note that this is the term as it stands in the original IALA Dictionary edition (1970-1989)

Volume velocity

3-1-085

Volume velocity (across a surface element)

The product of the area of the surface element and the component of the sound particle velocity perpendicular to the surface.

Reference: I.E.C.

Please note that this is the term as it stands in the original IALA Dictionary edition (1970-1989)

Volute of a siren

3-2-085

Volute (of a siren)

A component in the form of a spiral which distributes the compressed air evenly to the periphery of the stator.

Please note that this is the term as it stands in the original IALA Dictionary edition (1970-1989)

VTSO Position

The place in a VTS Centre from which a VTSO carries out his/her duties.

Source: IALA VTS Manual

VTS area

The delineated, formally declared service area of the VTS. A VTS area may be subdivided in sub-areas or sectors.

Source: IALA VTS Manual

VTS authority

The authority with responsibility for the management, operation and co-ordination of the VTS, interaction with participating vessels, and the safe and effective provision of the service.

Source: IALA VTS Manual

VTS centre

The centre from which the VTS is operated. Each sub-area of the VTS may have its own sub-centre.

Source: IALA VTS Manual

VTS Certification Log

A record of VTS related certificates and endorsements awarded to VTS personnel by the Competent and/or VTS Authority.

The record may, for example, be in the form of a logbook or the certificates themselves may be kept separately.

Source: IALA VTS Manual

VTS Manager

Some VTS organisations may require the appointment of a manager to administer and interface with regional or port management authorities.

In such circumstances the manager should possess managerial qualifications to the satisfaction of the Competent Authority.

Source: IALA VTS Manual

VTS Operator

An appropriately qualified person carrying out VTS operations on behalf of a VTS authority. (VTSO)

Source: IALA VTS Manual

VTS Operator Certificate

A VTS certificate of competence awarded by the Competent Authority after the candidate VTSO has successfully completed both the V103/1 training and OJT at the specific VTS centre where the VTSO is employed, as well as meeting any specific requirements of the Competent Authority.

Source: IALA VTS Manual

VTS Operator Course Certificate

A certificate awarded upon successful completion of the IALA Model Course V103/1 VTS Operator training at an accredited VTS training institute.

This course certificate alone is not an authorisation to operate as a VTSO.

Source: IALA VTS Manual

VTS Personnel

Persons trained in VTS operations, holding the appropriate qualifications required by a Competent Authority and acting as VTS Operator, VTS Supervisor and OJT Instructor at a VTS centre. VTS personnel may also include VTS Managers and Technical Support personnel. These latter personnel should ideally hold qualifications appropriate to the duties performed.

Source: IALA VTS Manual

VTS Sailing Plan (VTS Route Plan)

A plan that is mutually agreed between a VTS Authority and the master of a vessel concerning the movement of the vessel in a VTS area.

Source: IALA VTS Manual

VTS services

VTS should at least comprise an information service and may also include others, such as navigational assistance service or a traffic organization service, or both of these services, defined in Resolution A. 857(20), as follows:

- An information service is a service to ensure that essential information becomes available in time for on-board navigational decision-making.
- A navigational assistance service is a service to assist on-board navigational decision-making and to monitor its effects.
- A traffic organization service is a service to prevent the development of dangerous maritime traffic situations and to provide for the safe and efficient movement of vessel traffic within the VTS area.

Source: IALA VTS Manual

VTS Supervisor

An appropriately qualified VTSO carrying out supervisory duties in a VTS Centre on behalf of a VTS authority.

Source: IALA VTS Manual

VTS Supervisor Course Certificate

A certificate awarded upon successful completion of the IALA Model Course V-103/2 VTS Supervisor training at an accredited VTS training institute.

The course certificate alone is not an authorisation to operate as a VTS Supervisor.

Source: IALA VTS Manual

VTS traffic image

A VTS traffic image is the surface picture of vessels and their movements in a VTS area.

Source: IALA VTS Manual

Waling

7-2-250

Alternative term: Wale (USA)

A horizontal beam used to connect sheet piling or timber boarding retaining an excavation, to distribute the load.

Please note that this is the term as it stands in the original IALA Dictionary edition (1970-1989)

Wankel engine

6-2-035

An internal combustion engine without reciprocating parts, having an approximately triangular central rotor geared to the driving shaft.

Please note that this is the term as it stands in the original IALA Dictionary edition (1970-1989)

Warble tone

3-1-015

A tone whose frequency varies periodically about a mean value.

Reference: I.E.C.

Please note that this is the term as it stands in the original IALA Dictionary edition (1970-1989)

Warping end (GB)

8-3-100

Alternative term: Gipsy head (U.S.A.)

The small drum or barrel on the end of a winch or windlass shaft, used for handling line.

Please note that this is the term as it stands in the original IALA Dictionary edition (1970-1989)

Wash primer

7-3-500

Alternative ter: Etch primer

Primer for steel which has the effect of slightly etching the bare metal surface to improve the adhesion of a following paint treatment.

Please note that this is the term as it stands in the original IALA Dictionary edition (1970-1989)

Watch buoy

8-4-040

Alternative term: Station buoy (USA)

A buoy established in the vicinity of an aid to navigation such as a light vessel or Lanby, as a reference point in case the aid should drift off station.

Please note that this is the term as it stands in the original IALA Dictionary edition (1970-1989)

Watch Buoy (2)

2-6-205

Alternative term: Station Buoy (U.S.A.)

An unlighted buoy established in the vicinity of a lightship (or, in the U.S.A. and Germany, of an important lighted buoy) as a reference point in case the lightship or buoy should be dragged off station.

Please note that this is the term as it stands in the original IALA Dictionary edition (1970-1989)

Water-cooled engine

6-2-065

An engine cooled by the circulation of water through the cylinder block. The water transfers heat to a radiator, and the dissipation of the heat may be assisted by forced-air cooling of the radiator.

Please note that this is the term as it stands in the original IALA Dictionary edition (1970-1989)

Water-jet protected enclosure (or machine)

6-8-255

Alternative term: Hose-protected enclosure (or machine), hose-proof enclosure (or machine)

An enclosure (or machine) designed to prevent the ingress of jets of water reaching it from any direction.

Please note that this is the term as it stands in the original IALA Dictionary edition (1970-1989)

Waterbar

7-6-140

A strip of impervious material placed across a concrete joint to prevent water penetration.

Please note that this is the term as it stands in the original IALA Dictionary edition (1970-1989)

Watertight

7-6-540

Alternative term: Waterproof

Resistant to the penetration of water.

Please note that this is the term as it stands in the original IALA Dictionary edition (1970-1989)

Water and oil separator

6-2-270

A device installed in the discharge pipeline from a compressor to remove condensed moisture or lubricating oil from the compressed air.

Please note that this is the term as it stands in the original IALA Dictionary edition (1970-1989)

Water jetting

7-3-490

Alternative term: Water blasting

A method of cleaning a surface by projecting on to it a high pressure water jet, possibly also containing sand or grit.

Please note that this is the term as it stands in the original IALA Dictionary edition (1970-1989)

Water level

7-4-160

The height of the water surface in relation to the specific point with which the level is being compared.

Please note that this is the term as it stands in the original IALA Dictionary edition (1970-1989)

Watt-hour meter

6-8-175

An instrument that measures the consumption of energy in watt-hours.

Note: The term kilowatt-hour meter applies when the consumption is measured in kilowatt-hours.

Please note that this is the term as it stands in the original IALA Dictionary edition (1970-1989)

Wave

1-3-055

Wave (of the sea)

Oscillation of the surface of the sea, caused by local winds and less extensive than the swell.

Please note that this is the term as it stands in the original IALA Dictionary edition (1970-1989)

Wave-actuated generator

6-3-260

A generator that produces electric energy from the energy of wave motion. Usually the wave motion is used to compress a fluid to supply a turbine coupled to an electrical generator.

Please note that this is the term as it stands in the original IALA Dictionary edition (1970-1989)

Wave-train

1-1-275

Alternative term: Train of waves

A group of successive waves.

Reference: I.E.C.

Please note that this is the term as it stands in the original IALA Dictionary edition (1970-1989)

Waveguide

4-1-530

A system consisting of

- a. a metal tube
- b. a dielectric rod or tube, or
- c. a single wire

for the transmission of electromagnetic energy by a wave not of TEM type.

Reference: D.I.N. (modified)

Please note that this is the term as it stands in the original IALA Dictionary edition (1970-1989)

Wavelength

1-1-225

Distance in the direction of propagation of a periodic wave between two successive points at which the phase is the same (at the same time).

Symbol ??

Unit metre (m)

Reference: C.I.E. (extract)

Please note that this is the term as it stands in the original IALA Dictionary edition (1970-1989)

Wavelength (2)

4-1-010

The distance between corresponding points in consecutive cycles in a wave train, measured in the direction of propagation at any instant.

Reference: B.S. (modified)

Please note that this is the term as it stands in the original IALA Dictionary edition (1970-1989)

Wave (2)

7-4-055

One cycle of vertical motion of the sea surface. Note: In French a very sharp wave is called a lame.

Please note that this is the term as it stands in the original IALA Dictionary edition (1970-1989)

Wave antenna

4-1-495

Beverage antenna

A horizontal travelling wave directional antenna, usually long in relation to the wavelength, connected to the radio equipment at one end and connected to ground at the other through an impedance equal to the characteristic impedance. Its proper performance depends upon the wave tilt and is therefore most effective when erected over ground of low conductivity.

Please note that this is the term as it stands in the original IALA Dictionary edition (1970-1989)

Wave energy

6-3-255

Energy derived from the motion of water waves.

Please note that this is the term as it stands in the original IALA Dictionary edition (1970-1989)

Wave front

1-1-240

The part of the wave observed from the side towards which the wave is travelling.

Reference: I.E.C.

Please note that this is the term as it stands in the original IALA Dictionary edition (1970-1989)

Wave height

7-4-125

Overall vertical distance from the trough to the peak of a wave.

Please note that this is the term as it stands in the original IALA Dictionary edition (1970-1989)

Wave interference error

4-2-365

Wave interference error (in bearing)

Heiligtag effect (deprecated)

An error arising from the simultaneous reception of two or more waves arriving in different directions from a single transmitter.

Reference: B.S.

Please note that this is the term as it stands in the original IALA Dictionary edition (1970-1989)

Wave load

7-5-125

The loading applied to an object due to wave impact.

Please note that this is the term as it stands in the original IALA Dictionary edition (1970-1989)

Wave number

1-1-230

Reciprocal of wave length.

Symbol s

Unit $1/m$

Please note that this is the term as it stands in the original IALA Dictionary edition (1970-1989)

Wave reflection

7-4-140

Propagation of a wave in a direction different from the incident one after reflection from an obstacle which does not absorb all the wave energy.

Please note that this is the term as it stands in the original IALA Dictionary edition (1970-1989)

Wave surface

1-1-255

Surface produced by a progressive wave in space, containing points of equal phase of the oscillation.

For maritime use this term is also applied to the surface of the sea with waves.

Please note that this is the term as it stands in the original IALA Dictionary edition (1970-1989)

Wave tilt

4-1-875

For a ground wave polarized in the plane of propagation, the angle between the electric vector and the normal to the surface of the ground.

Reference: B.S.

Please note that this is the term as it stands in the original IALA Dictionary edition (1970-1989)

Wear-out-failure period

5-1-075

That possible period during which the failure rate is increasing rapidly due to deterioration processes.

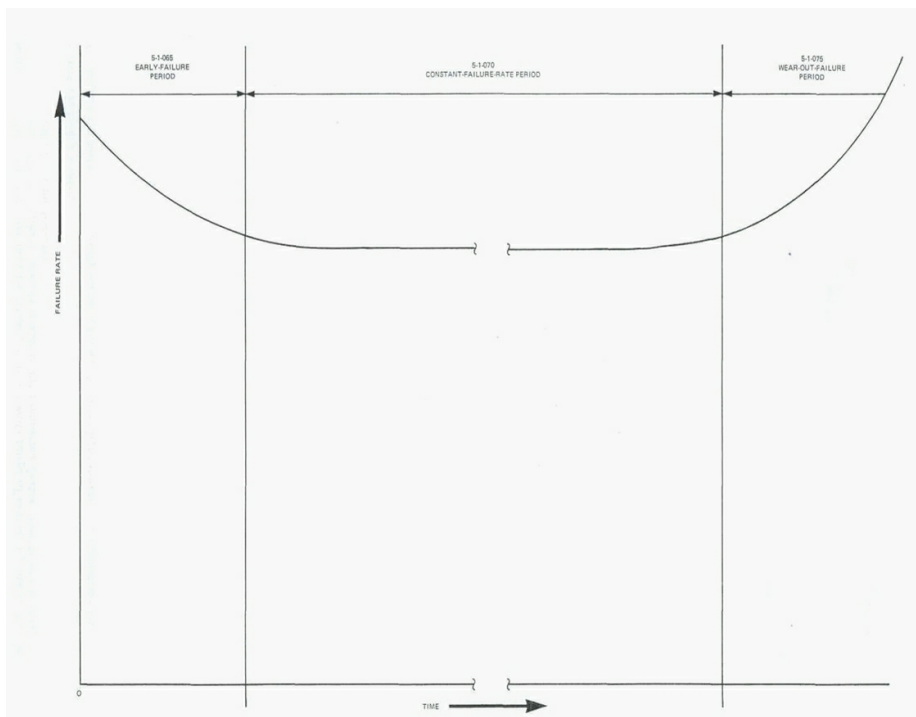

Figure 1 - Failure rate / time pattern.

Reference: I.E.C.

Please note that this is the term as it stands in the original IALA Dictionary edition (1970-1989)

Weather-protected enclosure (or machine)

6-8-260

Alternative term: Weatherproof enclosure (or machine)

An enclosure (or machine) designed to give protection, or to function normally, under specified weather conditions.

Please note that this is the term as it stands in the original IALA Dictionary edition (1970-1989)

Web (of a girder)

7-2-290

The central piece joining together the flanges of a girder.

Please note that this is the term as it stands in the original IALA Dictionary edition (1970-1989)

Weight tube

7-2-695

Tube running vertically through a lighthouse tower, usually centrally, up to the lantern level, which contains the weights for clockwork operated mechanisms.

Please note that this is the term as it stands in the original IALA Dictionary edition (1970-1989)

Well-strobe marker

4-3-345

Well-strobe marker (for an A-scan)

A form of strobe marker in which the discontinuity is in the form of a rectangular depression in the time-base.

Reference: B.S.

Please note that this is the term as it stands in the original IALA Dictionary edition (1970-1989)

Wet Dock

1-2-295

(Wet) Dock

Harbour or basin which is closed against the tidal range and which provides cargo-handling facilities for ships.

Note: In the U.S.A. the space between two piers which is not closed against the tidal range is also called a dock.

Please note that this is the term as it stands in the original IALA Dictionary edition (1970-1989)

Whip

8-3-060

The single-wire hoisting rope, usually led from a position below the main hoist on a derrick, which lifts light loads at high speed.

Please note that this is the term as it stands in the original IALA Dictionary edition (1970-1989)

Whip antenna

4-1-485

An antenna consisting of a flexible rod supported at one end.

Reference: B.S. (modified)

Please note that this is the term as it stands in the original IALA Dictionary edition (1970-1989)

Whistle

3-2-235

Fog signal apparatus comprising a resonator having an orifice of suitable shape such that when a jet of air is passed through the orifice the turbulence produces a sound.

Please note that this is the term as it stands in the original IALA Dictionary edition (1970-1989)

Whistle buoy

3-2-240

A buoy fitted with one or more whistles.

Please note that this is the term as it stands in the original IALA Dictionary edition (1970-1989)

Whistle Buoy (2)

2-6-190

A buoy fitted with one or more whistles.

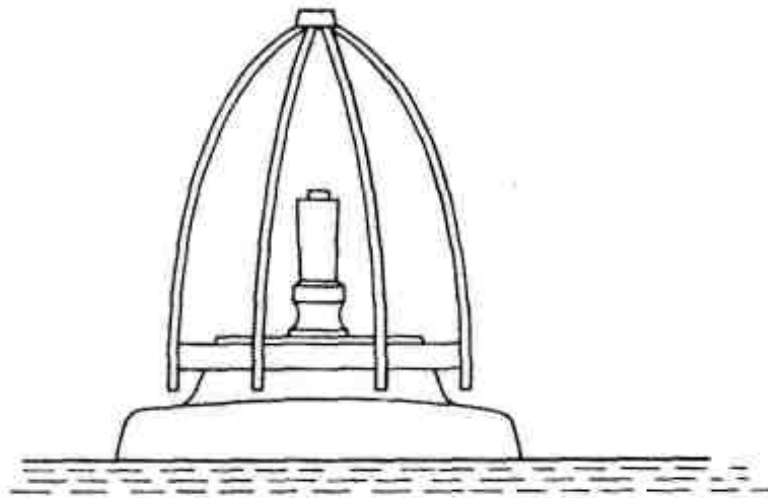

Please note that this is the term as it stands in the original IALA Dictionary edition (1970-1989)

White

2-1-490

Red:

Green:

White: A colour which has no readily discernible hue (2-1-440).

Note: A surface colour is considered to be "white" if its spectral luminance factor is approximately independent of wavelength and exceeds a value of about 0.7.

Red: In general, the hue of any monochromatic radiation in the visible spectrum at a wavelength greater than about 610 nm under conditions of photopic vision.

Green: In general, the hue of any monochromatic radiation in the visible spectrum at a wavelength between about 495 and 550 nm under conditions of photopic vision.

Note: These terms, when applied to colours of signal lights or to colour filters or surface colours (in the latter two cases for a specified or assumed reference illuminant), are defined by specifications of chromaticity limits established by various organisations.

Recommended values of these limits for application in all forms of transport service have been agreed internationally and are given in Reference: C.I.E. Publication No. 2 (W-1.3.3), 1959.

A "Recommendation for the Standardisation of Colours of Lighted Aids to Navigation" has been published by I.A.L.A. (April 1968).

Certain countries publish their own mandatory regulations for colour limits which lie within the boundaries of the Reference: C.I.E. recommendations.

Thus, in Great Britain, regulations for colour light signals and colour filters for all forms of transport, including maritime transport, are published in British Standard BS1376 1953.

In the U.S.A., similar regulations are given in the "U.S. Standard for the Colors of Signal Lights", National Bureau of Standards Handbook 95, August 1964.

In Germany, similar regulations are given in DIN 6163 Sheets 1 to 8, September 1959 and, for colour for traffic signals, DIN 6171 (May 1970)

Please note that this is the term as it stands in the original IALA Dictionary edition (1970-1989)

Wick

2-3-060

A strip of plaited material, usually cotton, which by capillary action draws liquid fuel from a reservoir to a burner.

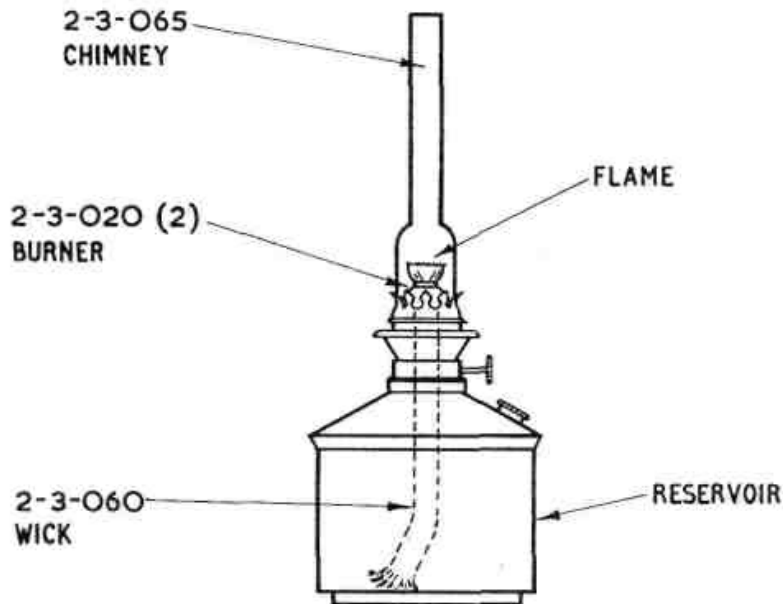

Please note that this is the term as it stands in the original IALA Dictionary edition (1970-1989)

Wide aperture direction finder

4-2-115

A direction finder in which the arriving wave front is received simultaneously (or nearly so) by an array of antennas, extending over a distance comparable to, or greater than, one wave length.

Reference: B.S.

Please note that this is the term as it stands in the original IALA Dictionary edition (1970-1989)

Wide aperture Doppler direction finder

4-2-120

A wide aperture direction finder in which, in addition, the Doppler effect is used to determine the true direction of the incident wave front.

Please note that this is the term as it stands in the original IALA Dictionary edition (1970-1989)

Winch

(2) 7-6-385

A device used for lifting or pulling in which a cable is wound onto a rotating drum.

Please note that this is the term as it stands in the original IALA Dictionary edition (1970-1989)

Wind-power generator

6-3-090

Alternative terms: Wind-driven generator, Wind-turbine generator, Aerogenerator

A rotary electric generator for which the motive power is the wind. The axis of rotation may be horizontal or vertical.

Note: The term "wind generator" is deprecated.

Please note that this is the term as it stands in the original IALA Dictionary edition (1970-1989)

Wind-vane

7-2-635

Alternative term: Weather-vane

A pivoted blade which rotates in the wind to show the direction of origin.

Please note that this is the term as it stands in the original IALA Dictionary edition (1970-1989)

Windlass

8-3-115

A special form of winch, fitted with clutched cable lifters for lifting and lowering the anchor. Drums or barrels may be fitted on the ends of the shafts, to permit handling of lines, for example for warping of the vessel alongside a quay.

Please note that this is the term as it stands in the original IALA Dictionary edition (1970-1989)

Wind bracing

7-2-025

Structural members, usually diagonal, designed to stiffen a structure to resist wind forces.

Please note that this is the term as it stands in the original IALA Dictionary edition (1970-1989)

Wind energy

6-3-080

Energy derived from the action of wind.

Please note that this is the term as it stands in the original IALA Dictionary edition (1970-1989)

Wind energy conversion system

6-3-085

Acronym: WECS

A system designed to convert wind energy into a usable form of energy.

Please note that this is the term as it stands in the original IALA Dictionary edition (1970-1989)

Wind load

7-5-100

The load imposed on a structure due to wind pressure.

Please note that this is the term as it stands in the original IALA Dictionary edition (1970-1989)

Wind shear

6-3-115

A variation of wind velocity in a plane normal to the wind direction, usually in the vertical direction.

Please note that this is the term as it stands in the original IALA Dictionary edition (1970-1989)

Wind speed duration curve

6-3-110

A characteristic depicting the cumulative hours the wind speed exceeds a specified wind speed in a year as a function of these specified speeds.

Please note that this is the term as it stands in the original IALA Dictionary edition (1970-1989)

Winter buoy

8-4-050

A buoy, often unlighted, used as a replacement for a light buoy or a large unlighted buoy in certain areas during the winter months when other aids to navigation are temporarily withdrawn.

Note 1:

The term ice buoy is used when the buoy is designed to withstand the effects of ice.

Note 2:

In German, the term Winterbetonnung means the state of the buoyage system as modified during the winter months.

Note 3:

The French term "bouee d'hiver" is not much used in France.

Please note that this is the term as it stands in the original IALA Dictionary edition (1970-1989)

Winter Buoy (U.S.A.)

2-6-200

An unlighted buoy which is maintained in certain areas during winter months when other navigational aids are temporarily removed or extinguished.

Please note that this is the term as it stands in the original IALA Dictionary edition (1970-1989)

Winter Light (U.S.A.)

2-5-090

A light which is in service during those winter months when the regular light is extinguished.

It is of lower intensity than the regular light but usually of the same character.

Please note that this is the term as it stands in the original IALA Dictionary edition (1970-1989)

Wire rope

8-3-015

Cordage made up of twisted strands of wire.

Please note that this is the term as it stands in the original IALA Dictionary edition (1970-1989)

Withdrawal

1-1-060

Removal or switching-off of an aid to navigation or of parts thereof, sometimes on a seasonal basis.

Please note that this is the term as it stands in the original IALA Dictionary edition (1970-1989)

Workability

7-6-025

A measure of the ease with which concrete can be placed, determined by standard test methods.

Please note that this is the term as it stands in the original IALA Dictionary edition (1970-1989)

Work barge

8-1-030

A boat used for :

- carrying out repairs and maintenance to fixed aids to navigation
- handling smaller buoys
- relief of personnel and fuelling and provisioning of lighthouses and light vessels.

Note :

No special term exists for this in German, but the general term Seezeichenfahrzeug includes work barges used by the lighthouse services (See note to 8-1-000).

Please note that this is the term as it stands in the original IALA Dictionary edition (1970-1989)

World-Wide Radio Navigation System

An IMO process whereby navigation system providers submit their systems for recognition. The requirements and procedures for acceptance are set out in IMO Resolution A.953(23).

Source: Nick Ward, Vicechair, IALA e-Nav Committee, March 2009

World geodetic system (WGS)

A consistent set of parameters describing the size and shape of the Earth, positions of a network of points with respect to the centre of mass of the Earth, transformations from major geodetic datums and the potential of the Earth.

WGS 84. The coordinate system used by GPS.

Source: Nick Ward, Vicechair, IALA e-Nav Committee, March 2009

Worst case

5-1-175

Usually for design or test purposes, the simultaneous application of the extremes of those various parameters likely to cause failure.

Please note that this is the term as it stands in the original IALA Dictionary edition (1970-1989)

Wreck

1-2-205

Any vessel or substantial parts thereof which is sunk or stranded or is no longer under control.

Note: For lighthouse services the term is extended also to accidental obstructions to navigation which normally are marked as an indication of danger.

Please note that this is the term as it stands in the original IALA Dictionary edition (1970-1989)

Wreck Mark (or Buoy)

2-6-105

Alternative term: Wreck-Marking Buoy

A mark (or buoy) marking the position of a wreck.

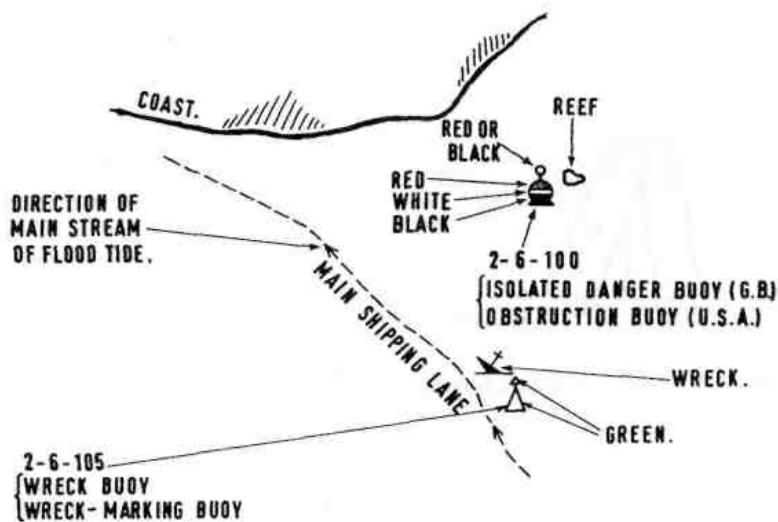

Please note that this is the term as it stands in the original IALA Dictionary edition (1970-1989)

Wrought iron

7-3-010

Malleable iron formed hot by forging. It has a lower carbon content than, and is softer than, steel.

Please note that this is the term as it stands in the original IALA Dictionary edition (1970-1989)

X-ray test

7-6-505

X-ray examination of materials and welds, used to detect defects.

Please note that this is the term as it stands in the original IALA Dictionary edition (1970-1989)

Yagi antenna

4-1-515

An antenna comprising one primary or fed element and two or more secondary or parasitic elements lying parallel to it in a single plane so as to constitute an end fire array. The usual arrangement of secondary elements consists of one reflector and one or more directors.

Reference: B.S. (modified)

Please note that this is the term as it stands in the original IALA Dictionary edition (1970-1989)

Yaw

6-3-210

A turning moment, in the horizontal plane, of the movable body of a wind-power generator in response to change in the direction of the wind.

Please note that this is the term as it stands in the original IALA Dictionary edition (1970-1989)

Zenith

1-2-120

(Observer's) Zenith

The point at which a straight line joining the centre of the earth to the observer's position meets the celestial sphere. To a particular observer it is the highest point of the celestial sphere.

Please note that this is the term as it stands in the original IALA Dictionary edition (1970-1989)

Zinc

7-3-045

A whitish-blue metal, used as a surface coating to steel to provide corrosion protection, or in sheet form as a roof covering.

Please note that this is the term as it stands in the original IALA Dictionary edition (1970-1989)

Zinc chromate primer

7-3-455

An anti-corrosion primer, bright yellow in colour, consisting of zinc chromate combined with some zinc hydroxide.

Please note that this is the term as it stands in the original IALA Dictionary edition (1970-1989)

Article Sources and Contributors

Tackle *Source:* <http://www.iala-aism.org/wiki/dictionary/index.php?oldid=837> *Contributors:* Oferiks

Tail chain *Source:* <http://www.iala-aism.org/wiki/dictionary/index.php?oldid=1033> *Contributors:* Oferiks

Tail tube (of a buoy) *Source:* <http://www.iala-aism.org/wiki/dictionary/index.php?oldid=971> *Contributors:* Oferiks

Tail vane *Source:* <http://www.iala-aism.org/wiki/dictionary/index.php?oldid=4589> *Contributors:* Oferiks

Tank circuit (G.B.) *Source:* <http://www.iala-aism.org/wiki/dictionary/index.php?oldid=2993> *Contributors:* Oferiks

Tank circuit (U.S.A.) *Source:* <http://www.iala-aism.org/wiki/dictionary/index.php?oldid=2995> *Contributors:* Oferiks

Taper charge *Source:* <http://www.iala-aism.org/wiki/dictionary/index.php?oldid=4889> *Contributors:* Oferiks

Tapper *Source:* <http://www.iala-aism.org/wiki/dictionary/index.php?oldid=2727> *Contributors:* Oferiks

Tar *Source:* <http://www.iala-aism.org/wiki/dictionary/index.php?oldid=5723> *Contributors:* Oferiks

Target trail *Source:* <http://www.iala-aism.org/wiki/dictionary/index.php?oldid=3381> *Contributors:* Oferiks

TB cell *Source:* <http://www.iala-aism.org/wiki/dictionary/index.php?oldid=3431> *Contributors:* Oferiks

Telemetry *Source:* <http://www.iala-aism.org/wiki/dictionary/index.php?oldid=4223> *Contributors:* Oferiks

Template *Source:* <http://www.iala-aism.org/wiki/dictionary/index.php?oldid=6231> *Contributors:* Oferiks

Temporary Light *Source:* <http://www.iala-aism.org/wiki/dictionary/index.php?oldid=7083> *Contributors:* Oferiks

Tender *Source:* <http://www.iala-aism.org/wiki/dictionary/index.php?oldid=6025> *Contributors:* Oferiks

Tenderer *Source:* <http://www.iala-aism.org/wiki/dictionary/index.php?oldid=6017> *Contributors:* Oferiks

Tendering procedure *Source:* <http://www.iala-aism.org/wiki/dictionary/index.php?oldid=6027> *Contributors:* Oferiks

Tension *Source:* <http://www.iala-aism.org/wiki/dictionary/index.php?oldid=5875> *Contributors:* Oferiks

Tension-cracked zone *Source:* <http://www.iala-aism.org/wiki/dictionary/index.php?oldid=6003> *Contributors:* Oferiks

Terminal (of a cell or battery) *Source:* <http://www.iala-aism.org/wiki/dictionary/index.php?oldid=4865> *Contributors:* Oferiks

Test boring *Source:* <http://www.iala-aism.org/wiki/dictionary/index.php?oldid=5861> *Contributors:* Oferiks

Test load *Source:* <http://www.iala-aism.org/wiki/dictionary/index.php?oldid=5899> *Contributors:* Oferiks

Test sample *Source:* <http://www.iala-aism.org/wiki/dictionary/index.php?oldid=6009> *Contributors:* Oferiks

Thermal Radiation *Source:* <http://www.iala-aism.org/wiki/dictionary/index.php?oldid=6597> *Contributors:* Oferiks

Thermal Radiator *Source:* <http://www.iala-aism.org/wiki/dictionary/index.php?oldid=6599> *Contributors:* Oferiks

Thermal relay *Source:* <http://www.iala-aism.org/wiki/dictionary/index.php?oldid=4309> *Contributors:* Oferiks

Thermic lance *Source:* <http://www.iala-aism.org/wiki/dictionary/index.php?oldid=6241> *Contributors:* Oferiks

Thermocouple *Source:* <http://www.iala-aism.org/wiki/dictionary/index.php?oldid=4313> *Contributors:* Oferiks

Thermocouple (2) *Source:* <http://www.iala-aism.org/wiki/dictionary/index.php?oldid=4629> *Contributors:* Oferiks

Thermoelectric generator *Source:* <http://www.iala-aism.org/wiki/dictionary/index.php?oldid=4627> *Contributors:* Oferiks

Thermoplastic *Source:* <http://www.iala-aism.org/wiki/dictionary/index.php?oldid=5635> *Contributors:* Oferiks

Thrash (chain) *Source:* <http://www.iala-aism.org/wiki/dictionary/index.php?oldid=1023> *Contributors:* Oferiks

Three-phase alternator *Source:* <http://www.iala-aism.org/wiki/dictionary/index.php?oldid=4743> *Contributors:* Oferiks

Threshold of hearing *Source:* <http://www.iala-aism.org/wiki/dictionary/index.php?oldid=2588> *Contributors:* Oferiks

Threshold of Illuminance *Source:* <http://www.iala-aism.org/wiki/dictionary/index.php?oldid=6601> *Contributors:* Oferiks

Threshold of perception *Source:* <http://www.iala-aism.org/wiki/dictionary/index.php?oldid=1254> *Contributors:* Oferiks

Threshold signal *Source:* <http://www.iala-aism.org/wiki/dictionary/index.php?oldid=2795> *Contributors:* Oferiks

Threshold value (or alert limit) *Source:* <http://www.iala-aism.org/wiki/dictionary/index.php?oldid=7719> *Contributors:* Oferiks

Thrust block *Source:* <http://www.iala-aism.org/wiki/dictionary/index.php?oldid=6089> *Contributors:* Oferiks

Tidal bore *Source:* <http://www.iala-aism.org/wiki/dictionary/index.php?oldid=5763> *Contributors:* Oferiks

Tidal cycle *Source:* <http://www.iala-aism.org/wiki/dictionary/index.php?oldid=5765> *Contributors:* Oferiks

Tidal energy *Source:* <http://www.iala-aism.org/wiki/dictionary/index.php?oldid=4623> *Contributors:* Oferiks

Tidal flat *Source:* <http://www.iala-aism.org/wiki/dictionary/index.php?oldid=5741> *Contributors:* Oferiks

Tidal range *Source:* <http://www.iala-aism.org/wiki/dictionary/index.php?oldid=1392> *Contributors:* Oferiks

Tide *Source:* <http://www.iala-aism.org/wiki/dictionary/index.php?oldid=1380> *Contributors:* Oferiks

Tide-actuated generator *Source:* <http://www.iala-aism.org/wiki/dictionary/index.php?oldid=4625> *Contributors:* Oferiks

Tide - Ebb tide *Source:* <http://www.iala-aism.org/wiki/dictionary/index.php?oldid=1382> *Contributors:* Oferiks

Tide - Flood tide *Source:* <http://www.iala-aism.org/wiki/dictionary/index.php?oldid=1384> *Contributors:* Oferiks

Tide - Half-tide *Source:* <http://www.iala-aism.org/wiki/dictionary/index.php?oldid=1390> *Contributors:* Oferiks

Tide - High tide *Source:* <http://www.iala-aism.org/wiki/dictionary/index.php?oldid=1388> *Contributors:* Oferiks

Tide - Low tide *Source:* <http://www.iala-aism.org/wiki/dictionary/index.php?oldid=1386> *Contributors:* Oferiks

Tide - Neap tides *Source:* <http://www.iala-aism.org/wiki/dictionary/index.php?oldid=1396> *Contributors:* Oferiks

Tide - Spring tides *Source:* <http://www.iala-aism.org/wiki/dictionary/index.php?oldid=1398> *Contributors:* Oferiks

Tide gauge *Source:* <http://www.iala-aism.org/wiki/dictionary/index.php?oldid=5491> *Contributors:* Oferiks

Tide Signals *Source:* <http://www.iala-aism.org/wiki/dictionary/index.php?oldid=7153> *Contributors:* Oferiks

Tie *Source:* <http://www.iala-aism.org/wiki/dictionary/index.php?oldid=5291> *Contributors:* Oferiks

Tile *Source:* <http://www.iala-aism.org/wiki/dictionary/index.php?oldid=5569> *Contributors:* Oferiks

Timber *Source:* <http://www.iala-aism.org/wiki/dictionary/index.php?oldid=5647> *Contributors:* Oferiks

Timbre *Source:* <http://www.iala-aism.org/wiki/dictionary/index.php?oldid=2578> *Contributors:* Oferiks

Time delay switch *Source:* <http://www.iala-aism.org/wiki/dictionary/index.php?oldid=5133> *Contributors:* Oferiks

Time division multiplex (TDM) *Source:* <http://www.iala-aism.org/wiki/dictionary/index.php?oldid=4023> *Contributors:* Oferiks

Time switch *Source:* <http://www.iala-aism.org/wiki/dictionary/index.php?oldid=1242> *Contributors:* Oferiks

Time Switch *Source:* <http://www.iala-aism.org/wiki/dictionary/index.php?oldid=6979> *Contributors:* Oferiks

Time switch (2) *Source:* <http://www.iala-aism.org/wiki/dictionary/index.php?oldid=5157> *Contributors:* Oferiks

Time to alarm *Source:* <http://www.iala-aism.org/wiki/dictionary/index.php?oldid=7721> *Contributors:* Oferiks

Tin *Source:* <http://www.iala-aism.org/wiki/dictionary/index.php?oldid=5531> *Contributors:* Oferiks

Tip speed ratio *Source:* <http://www.iala-aism.org/wiki/dictionary/index.php?oldid=4577> *Contributors:* Oferiks

Topmark *Source:* <http://www.iala-aism.org/wiki/dictionary/index.php?oldid=953> *Contributors:* Oferiks

Topmark (2) *Source:* <http://www.iala-aism.org/wiki/dictionary/index.php?oldid=7191> *Contributors:* Oferiks

Topping lift *Source:* <http://www.iala-aism.org/wiki/dictionary/index.php?oldid=841> *Contributors:* Oferiks

Top loaded antenna *Source:* <http://www.iala-aism.org/wiki/dictionary/index.php?oldid=2923> *Contributors:* Oferiks

Toran *Source:* <http://www.iala-aism.org/wiki/dictionary/index.php?oldid=3719> *Contributors:* Oferiks

Toran chain *Source:* <http://www.iala-aism.org/wiki/dictionary/index.php?oldid=3729> *Contributors:* Oferiks

Toran chart *Source:* <http://www.iala-aism.org/wiki/dictionary/index.php?oldid=3731> *Contributors:* Oferiks

Toran Compensating receiver *Source:* <http://www.iala-aism.org/wiki/dictionary/index.php?oldid=3723> *Contributors:* Oferiks

Toran Confocal emitters *Source:* <http://www.iala-aism.org/wiki/dictionary/index.php?oldid=3721> *Contributors:* Oferiks

Toran couple *Source:* <http://www.iala-aism.org/wiki/dictionary/index.php?oldid=3727> *Contributors:* Oferiks

Toran Reference transmitter *Source:* <http://www.iala-aism.org/wiki/dictionary/index.php?oldid=3725> *Contributors:* Oferiks

Torque *Source:* <http://www.iala-aism.org/wiki/dictionary/index.php?oldid=5977> *Contributors:* Oferiks

Totally enclosed enclosure (or machine) *Source:* <http://www.iala-aism.org/wiki/dictionary/index.php?oldid=5151> *Contributors:* Oferiks

Total amplitude of oscillation *Source:* <http://www.iala-aism.org/wiki/dictionary/index.php?oldid=1200> *Contributors:* Oferiks

Total earthing resistance *Source:* <http://www.iala-aism.org/wiki/dictionary/index.php?oldid=5093> *Contributors:* Oferiks

Total loss *Source:* <http://www.iala-aism.org/wiki/dictionary/index.php?oldid=5085> *Contributors:* Oferiks

Total polarization error *Source:* <http://www.iala-aism.org/wiki/dictionary/index.php?oldid=3301> *Contributors:* Oferiks

Total System Error (TSE) *Source:* <http://www.iala-aism.org/wiki/dictionary/index.php?oldid=7723> *Contributors:* Oferiks

Tower (of a wind-power generator) *Source:* <http://www.iala-aism.org/wiki/dictionary/index.php?oldid=4587> *Contributors:* Oferiks

Tower crane *Source:* <http://www.iala-aism.org/wiki/dictionary/index.php?oldid=6203> *Contributors:* Oferiks

Tower rock light *Source:* <http://www.iala-aism.org/wiki/dictionary/index.php?oldid=5169> *Contributors:* Oferiks

Towing *Source:* <http://www.iala-aism.org/wiki/dictionary/index.php?oldid=6163> *Contributors:* Oferiks

Towing winch *Source:* <http://www.iala-aism.org/wiki/dictionary/index.php?oldid=867> *Contributors:* Oferiks

To bend *Source:* <http://www.iala-aism.org/wiki/dictionary/index.php?oldid=6229> *Contributors:* Oferiks

To bolt *Source:* <http://www.iala-aism.org/wiki/dictionary/index.php?oldid=6227> *Contributors:* Oferiks

To braze *Source:* <http://www.iala-aism.org/wiki/dictionary/index.php?oldid=6225> *Contributors:* Oferiks

To level (surveying) *Source:* <http://www.iala-aism.org/wiki/dictionary/index.php?oldid=6265> *Contributors:* Oferiks

To level off *Source:* <http://www.iala-aism.org/wiki/dictionary/index.php?oldid=6077> *Contributors:* Oferiks

To pour (concrete) *Source:* <http://www.iala-aism.org/wiki/dictionary/index.php?oldid=6063> *Contributors:* Oferiks

To rivet *Source:* <http://www.iala-aism.org/wiki/dictionary/index.php?oldid=6233> *Contributors:* Oferiks

To solder *Source:* <http://www.iala-aism.org/wiki/dictionary/index.php?oldid=6235> *Contributors:* Oferiks

To strike (formwork) *Source:* <http://www.iala-aism.org/wiki/dictionary/index.php?oldid=6097> *Contributors:* Oferiks

To strike off *Source:* <http://www.iala-aism.org/wiki/dictionary/index.php?oldid=6079> *Contributors:* Oferiks

To weld *Source:* <http://www.iala-aism.org/wiki/dictionary/index.php?oldid=6237> *Contributors:* Oferiks

Trailing edge *Source:* <http://www.iala-aism.org/wiki/dictionary/index.php?oldid=4565> *Contributors:* Oferiks

Transfer function *Source:* <http://www.iala-aism.org/wiki/dictionary/index.php?oldid=3901> *Contributors:* Oferiks

Transformation of electric energy *Source:* <http://www.iala-aism.org/wiki/dictionary/index.php?oldid=5009> *Contributors:* Oferiks

Transformer *Source:* <http://www.iala-aism.org/wiki/dictionary/index.php?oldid=5013> *Contributors:* Oferiks

Transient deviation *Source:* <http://www.iala-aism.org/wiki/dictionary/index.php?oldid=3897> *Contributors:* Oferiks

Transition Mark (or Buoy) *Source:* <http://www.iala-aism.org/wiki/dictionary/index.php?oldid=7133> *Contributors:* Oferiks

Transmission *Source:* <http://www.iala-aism.org/wiki/dictionary/index.php?oldid=1150> *Contributors:* Oferiks

Transmission bridge *Source:* <http://www.iala-aism.org/wiki/dictionary/index.php?oldid=4343> *Contributors:* Oferiks

Transmission of electric energy *Source:* <http://www.iala-aism.org/wiki/dictionary/index.php?oldid=4891> *Contributors:* Oferiks

Transmission schedule *Source:* <http://www.iala-aism.org/wiki/dictionary/index.php?oldid=3175> *Contributors:* Oferiks

Transmissivity *Source:* <http://www.iala-aism.org/wiki/dictionary/index.php?oldid=6603> *Contributors:* Oferiks

Transmissometer *Source:* <http://www.iala-aism.org/wiki/dictionary/index.php?oldid=4377> *Contributors:* Oferiks

Transmittance *Source:* <http://www.iala-aism.org/wiki/dictionary/index.php?oldid=6605> *Contributors:* Oferiks

Transmitter load *Source:* <http://www.iala-aism.org/wiki/dictionary/index.php?oldid=3007> *Contributors:* Oferiks

Transmitter power gain *Source:* <http://www.iala-aism.org/wiki/dictionary/index.php?oldid=3005> *Contributors:* Oferiks

Transponder *Source:* <http://www.iala-aism.org/wiki/dictionary/index.php?oldid=3519> *Contributors:* Oferiks

Transponder dead time *Source:* <http://www.iala-aism.org/wiki/dictionary/index.php?oldid=3539> *Contributors:* Oferiks

Transponder reply efficiency *Source:* <http://www.iala-aism.org/wiki/dictionary/index.php?oldid=3537> *Contributors:* Oferiks

Tremie hopper *Source:* <http://www.iala-aism.org/wiki/dictionary/index.php?oldid=6215> *Contributors:* Oferiks

Trench sheeting *Source:* <http://www.iala-aism.org/wiki/dictionary/index.php?oldid=6145> *Contributors:* Oferiks

Trestle *Source:* <http://www.iala-aism.org/wiki/dictionary/index.php?oldid=5333> *Contributors:* Oferiks

Triad *Source:* <http://www.iala-aism.org/wiki/dictionary/index.php?oldid=3159> *Contributors:* Oferiks

Triangle of error *Source:* <http://www.iala-aism.org/wiki/dictionary/index.php?oldid=1288> *Contributors:* Oferiks

Trichromatic System *Source:* <http://www.iala-aism.org/wiki/dictionary/index.php?oldid=6607> *Contributors:* Oferiks

Trickle charge *Source:* <http://www.iala-aism.org/wiki/dictionary/index.php?oldid=4881> *Contributors:* Oferiks

Trigatron *Source:* <http://www.iala-aism.org/wiki/dictionary/index.php?oldid=3509> *Contributors:* Oferiks

Triggered spark-gap *Source:* <http://www.iala-aism.org/wiki/dictionary/index.php?oldid=3507> *Contributors:* Oferiks

Triggering *Source:* <http://www.iala-aism.org/wiki/dictionary/index.php?oldid=3533> *Contributors:* Oferiks

Trigger level *Source:* <http://www.iala-aism.org/wiki/dictionary/index.php?oldid=3535> *Contributors:* Oferiks

Trimming *Source:* <http://www.iala-aism.org/wiki/dictionary/index.php?oldid=6763> *Contributors:* Oferiks

Tristimulus Values *Source:* <http://www.iala-aism.org/wiki/dictionary/index.php?oldid=6609> *Contributors:* Oferiks

Troland *Source:* <http://www.iala-aism.org/wiki/dictionary/index.php?oldid=6611> *Contributors:* Oferiks

Troposphere *Source:* <http://www.iala-aism.org/wiki/dictionary/index.php?oldid=3125> *Contributors:* Oferiks

Tropospheric radio duct *Source:* <http://www.iala-aism.org/wiki/dictionary/index.php?oldid=3141> *Contributors:* Oferiks

Tropospheric wave *Source:* <http://www.iala-aism.org/wiki/dictionary/index.php?oldid=3135> *Contributors:* Oferiks

Trough (of a wave) *Source:* <http://www.iala-aism.org/wiki/dictionary/index.php?oldid=5781> *Contributors:* Oferiks

True motion display *Source:* <http://www.iala-aism.org/wiki/dictionary/index.php?oldid=3405> *Contributors:* Oferiks

True position *Source:* <http://www.iala-aism.org/wiki/dictionary/index.php?oldid=7725> *Contributors:* Oferiks

Truss (of a roof) *Source:* <http://www.iala-aism.org/wiki/dictionary/index.php?oldid=5303> *Contributors:* Oferiks

TR cavity *Source:* <http://www.iala-aism.org/wiki/dictionary/index.php?oldid=3433> *Contributors:* Oferiks

TR cell *Source:* <http://www.iala-aism.org/wiki/dictionary/index.php?oldid=3429> *Contributors:* Oferiks

TR switch *Source:* <http://www.iala-aism.org/wiki/dictionary/index.php?oldid=3427> *Contributors:* Oferiks

TR switch and beam switching combined *Source:* <http://www.iala-aism.org/wiki/dictionary/index.php?oldid=3511> *Contributors:* Oferiks

Tsunami *Source:* <http://www.iala-aism.org/wiki/dictionary/index.php?oldid=5767> *Contributors:* Oferiks

Tube *Source:* <http://www.iala-aism.org/wiki/dictionary/index.php?oldid=5323> *Contributors:* Oferiks

Tubular Discharge Lamp *Source:* <http://www.iala-aism.org/wiki/dictionary/index.php?oldid=6867> *Contributors:* Oferiks

Tubular Lamp *Source:* <http://www.iala-aism.org/wiki/dictionary/index.php?oldid=6801> *Contributors:* Oferiks

Tuned antenna *Source:* <http://www.iala-aism.org/wiki/dictionary/index.php?oldid=2839> *Contributors:* Oferiks

Tungsten-Halogen Lamp *Source:* <http://www.iala-aism.org/wiki/dictionary/index.php?oldid=6797> *Contributors:* Oferiks

Turbulence *Source:* <http://www.iala-aism.org/wiki/dictionary/index.php?oldid=4555> *Contributors:* Oferiks

Two-motion selector *Source:* <http://www.iala-aism.org/wiki/dictionary/index.php?oldid=4341> *Contributors:* Oferiks

Two-step relay *Source:* <http://www.iala-aism.org/wiki/dictionary/index.php?oldid=4303> *Contributors:* Oferiks

Two-stroke engine *Source:* <http://www.iala-aism.org/wiki/dictionary/index.php?oldid=4411> *Contributors:* Oferiks

Two-wire repeater *Source:* <http://www.iala-aism.org/wiki/dictionary/index.php?oldid=4329> *Contributors:* Oferiks

Two buoys mored abreast in a channel *Source:* <http://www.iala-aism.org/wiki/dictionary/index.php?oldid=7145> *Contributors:* Oferiks

Two buoys mored not abreast in a channel *Source:* <http://www.iala-aism.org/wiki/dictionary/index.php?oldid=7147> *Contributors:* Oferiks

Types of service *Source:* <http://www.iala-aism.org/wiki/dictionary/index.php?oldid=3179> *Contributors:* Oferiks

Type DM Raydist *Source:* <http://www.iala-aism.org/wiki/dictionary/index.php?oldid=3697> *Contributors:* Oferiks

Type E Raydist *Source:* <http://www.iala-aism.org/wiki/dictionary/index.php?oldid=3699> *Contributors:* Oferiks

Type M Raydist *Source:* <http://www.iala-aism.org/wiki/dictionary/index.php?oldid=3693> *Contributors:* Oferiks

Type N Raydist *Source:* <http://www.iala-aism.org/wiki/dictionary/index.php?oldid=3695> *Contributors:* Oferiks

T antenna *Source:* <http://www.iala-aism.org/wiki/dictionary/index.php?oldid=2927> *Contributors:* Oferiks

Ultrasonic test *Source:* <http://www.iala-aism.org/wiki/dictionary/index.php?oldid=6259> *Contributors:* Oferiks

Umbrella antenna *Source:* <http://www.iala-aism.org/wiki/dictionary/index.php?oldid=2931> *Contributors:* Oferiks

Undercutting (of cliffs) *Source:* <http://www.iala-aism.org/wiki/dictionary/index.php?oldid=5841> *Contributors:* Oferiks

Underground (power) cable *Source:* <http://www.iala-aism.org/wiki/dictionary/index.php?oldid=4919> *Contributors:* Oferiks

Undisturbed soil sample *Source:* <http://www.iala-aism.org/wiki/dictionary/index.php?oldid=5853> *Contributors:* Oferiks

Uniformly distributed load *Source:* <http://www.iala-aism.org/wiki/dictionary/index.php?oldid=5895> *Contributors:* Oferiks

Uniform Diffuser *Source:* <http://www.iala-aism.org/wiki/dictionary/index.php?oldid=6613> *Contributors:* Oferiks

Uninterrupted duty *Source:* <http://www.iala-aism.org/wiki/dictionary/index.php?oldid=4707> *Contributors:* Oferiks

Unipole antenna *Source:* <http://www.iala-aism.org/wiki/dictionary/index.php?oldid=2913> *Contributors:* Oferiks

Universal motor *Source:* <http://www.iala-aism.org/wiki/dictionary/index.php?oldid=4757> *Contributors:* Oferiks

Unlighted Buoy *Source:* <http://www.iala-aism.org/wiki/dictionary/index.php?oldid=7159> *Contributors:* Oferiks

Unwatched Light *Source:* <http://www.iala-aism.org/wiki/dictionary/index.php?oldid=7085> *Contributors:* Oferiks

Updating/Refresher Training *Source:* <http://www.iala-aism.org/wiki/dictionary/index.php?oldid=7462> *Contributors:* Oferiks

Upright *Source:* <http://www.iala-aism.org/wiki/dictionary/index.php?oldid=5317> *Contributors:* Oferiks

Useful Life (of a lamp) *Source:* <http://www.iala-aism.org/wiki/dictionary/index.php?oldid=6911> *Contributors:* Oferiks

Usual range of a sound signal *Source:* <http://www.iala-aism.org/wiki/dictionary/index.php?oldid=2610> *Contributors:* Oferiks

Utilisation factor *Source:* <http://www.iala-aism.org/wiki/dictionary/index.php?oldid=5071> *Contributors:* Oferiks

Utilisation of energy *Source:* <http://www.iala-aism.org/wiki/dictionary/index.php?oldid=5049> *Contributors:* Oferiks

Vacuum Lamp *Source:* <http://www.iala-aism.org/wiki/dictionary/index.php?oldid=6793> *Contributors:* Oferiks

Valve (of an internal combustion engine) *Source:* <http://www.iala-aism.org/wiki/dictionary/index.php?oldid=4449> *Contributors:* Oferiks

Vaporiser *Source:* <http://www.iala-aism.org/wiki/dictionary/index.php?oldid=6981> *Contributors:* Oferiks

Variable-pitch blade *Source:* <http://www.iala-aism.org/wiki/dictionary/index.php?oldid=4569> *Contributors:* Oferiks

Variable auto-transformer *Source:* <http://www.iala-aism.org/wiki/dictionary/index.php?oldid=5117> *Contributors:* Oferiks

Velodyne integrator *Source:* <http://www.iala-aism.org/wiki/dictionary/index.php?oldid=4285> *Contributors:* Oferiks

Ventilator (passive) *Source:* <http://www.iala-aism.org/wiki/dictionary/index.php?oldid=5481> *Contributors:* Oferiks

Ventilator (powered) *Source:* <http://www.iala-aism.org/wiki/dictionary/index.php?oldid=5483> *Contributors:* Oferiks

Vent plug *Source:* <http://www.iala-aism.org/wiki/dictionary/index.php?oldid=4869> *Contributors:* Oferiks

Vertex plate *Source:* <http://www.iala-aism.org/wiki/dictionary/index.php?oldid=2969> *Contributors:* Oferiks

Vertically polarized wave *Source:* <http://www.iala-aism.org/wiki/dictionary/index.php?oldid=3083> *Contributors:* Oferiks

Vertical antenna *Source:* <http://www.iala-aism.org/wiki/dictionary/index.php?oldid=2921> *Contributors:* Oferiks

Vertical beam width *Source:* <http://www.iala-aism.org/wiki/dictionary/index.php?oldid=2905> *Contributors:* Oferiks

Vessel Technical Error (VTE) *Source:* <http://www.iala-aism.org/wiki/dictionary/index.php?oldid=7727> *Contributors:* Oferiks

Vessel Traffic Management *Source:* <http://www.iala-aism.org/wiki/dictionary/index.php?oldid=7619> *Contributors:* Oferiks

Vessel Traffic Service *Source:* <http://www.iala-aism.org/wiki/dictionary/index.php?oldid=7464> *Contributors:* Oferiks

Vestigial sideband *Source:* <http://www.iala-aism.org/wiki/dictionary/index.php?oldid=4053> *Contributors:* Oferiks

Vibration *Source:* <http://www.iala-aism.org/wiki/dictionary/index.php?oldid=5815> *Contributors:* Oferiks

Vibration (2) *Source:* <http://www.iala-aism.org/wiki/dictionary/index.php?oldid=6031> *Contributors:* Oferiks

Vibrator *Source:* <http://www.iala-aism.org/wiki/dictionary/index.php?oldid=6061> *Contributors:* Oferiks

Vibratory pile driving *Source:* <http://www.iala-aism.org/wiki/dictionary/index.php?oldid=6121> *Contributors:* Oferiks

Video mapping *Source:* <http://www.iala-aism.org/wiki/dictionary/index.php?oldid=3411> *Contributors:* Oferiks

Viscosity *Source:* <http://www.iala-aism.org/wiki/dictionary/index.php?oldid=6043> *Contributors:* Oferiks

Visibility *Source:* <http://www.iala-aism.org/wiki/dictionary/index.php?oldid=6615> *Contributors:* Oferiks

Visibility meter *Source:* <http://www.iala-aism.org/wiki/dictionary/index.php?oldid=4375> *Contributors:* Oferiks

Vision *Source:* <http://www.iala-aism.org/wiki/dictionary/index.php?oldid=6617> *Contributors:* Oferiks

Visual Photometer *Source:* <http://www.iala-aism.org/wiki/dictionary/index.php?oldid=6619> *Contributors:* Oferiks

Visual Range *Source:* <http://www.iala-aism.org/wiki/dictionary/index.php?oldid=6621> *Contributors:* Oferiks

Void ratio *Source:* <http://www.iala-aism.org/wiki/dictionary/index.php?oldid=5825> *Contributors:* Oferiks

Voltage (sensitive) relay *Source:* <http://www.iala-aism.org/wiki/dictionary/index.php?oldid=4297> *Contributors:* Oferiks

Voltage stabiliser *Source:* <http://www.iala-aism.org/wiki/dictionary/index.php?oldid=5043> *Contributors:* Oferiks

Voltage standing-wave ratio *Source:* <http://www.iala-aism.org/wiki/dictionary/index.php?oldid=2959> *Contributors:* Oferiks

Volume velocity *Source:* <http://www.iala-aism.org/wiki/dictionary/index.php?oldid=2542> *Contributors:* Oferiks

Volute of a siren *Source:* <http://www.iala-aism.org/wiki/dictionary/index.php?oldid=2649> *Contributors:* Oferiks

VTSO Position *Source:* <http://www.iala-aism.org/wiki/dictionary/index.php?oldid=7484> *Contributors:* Oferiks

VTS area *Source:* <http://www.iala-aism.org/wiki/dictionary/index.php?oldid=7468> *Contributors:* Oferiks

VTS authority *Source:* <http://www.iala-aism.org/wiki/dictionary/index.php?oldid=7466> *Contributors:* Oferiks

VTS centre *Source:* <http://www.iala-aism.org/wiki/dictionary/index.php?oldid=7470> *Contributors:* Oferiks

VTS Certification Log *Source:* <http://www.iala-aism.org/wiki/dictionary/index.php?oldid=7472> *Contributors:* Oferiks

VTS Manager *Source:* <http://www.iala-aism.org/wiki/dictionary/index.php?oldid=7474> *Contributors:* Oferiks

VTS Operator *Source:* <http://www.iala-aism.org/wiki/dictionary/index.php?oldid=7476> *Contributors:* Oferiks

VTS Operator Certificate *Source:* <http://www.iala-aism.org/wiki/dictionary/index.php?oldid=7480> *Contributors:* Oferiks

VTS Operator Course Certificate *Source:* <http://www.iala-aism.org/wiki/dictionary/index.php?oldid=7478> *Contributors:* Oferiks

VTS Personnel *Source:* <http://www.iala-aism.org/wiki/dictionary/index.php?oldid=7482> *Contributors:* Oferiks

VTS Sailing Plan (VTS Route Plan) *Source:* <http://www.iala-aism.org/wiki/dictionary/index.php?oldid=7486> *Contributors:* Oferiks

VTS services *Source:* <http://www.iala-aism.org/wiki/dictionary/index.php?oldid=7488> *Contributors:* Oferiks

VTS Supervisor *Source:* <http://www.iala-aism.org/wiki/dictionary/index.php?oldid=7490> *Contributors:* Oferiks

VTS Supervisor Course Certificate *Source:* <http://www.iala-aism.org/wiki/dictionary/index.php?oldid=7492> *Contributors:* Oferiks

VTS traffic image *Source:* <http://www.iala-aism.org/wiki/dictionary/index.php?oldid=7494> *Contributors:* Oferiks

Waling *Source:* <http://www.iala-aism.org/wiki/dictionary/index.php?oldid=5331> *Contributors:* Oferiks

Wankel engine *Source:* <http://www.iala-aism.org/wiki/dictionary/index.php?oldid=4407> *Contributors:* Oferiks

Warble tone *Source:* <http://www.iala-aism.org/wiki/dictionary/index.php?oldid=2514> *Contributors:* Oferiks

Warping end (GB) *Source:* <http://www.iala-aism.org/wiki/dictionary/index.php?oldid=865> *Contributors:* Oferiks

Wash primer *Source:* <http://www.iala-aism.org/wiki/dictionary/index.php?oldid=5709> *Contributors:* Oferiks

Watch buoy *Source:* <http://www.iala-aism.org/wiki/dictionary/index.php?oldid=931> *Contributors:* Oferiks

Watch Buoy (2) *Source:* <http://www.iala-aism.org/wiki/dictionary/index.php?oldid=7171> *Contributors:* Oferiks

Water-cooled engine *Source:* <http://www.iala-aism.org/wiki/dictionary/index.php?oldid=4419> *Contributors:* Oferiks

Water-jet protected enclosure (or machine) *Source:* <http://www.iala-aism.org/wiki/dictionary/index.php?oldid=5147> *Contributors:* Oferiks

Waterbar *Source:* <http://www.iala-aism.org/wiki/dictionary/index.php?oldid=6111> *Contributors:* Oferiks

Watertight *Source:* <http://www.iala-aism.org/wiki/dictionary/index.php?oldid=6269> *Contributors:* Oferiks

Water and oil separator *Source:* <http://www.iala-aism.org/wiki/dictionary/index.php?oldid=4501> *Contributors:* Oferiks

Water jetting *Source:* <http://www.iala-aism.org/wiki/dictionary/index.php?oldid=5705> *Contributors:* Oferiks

Water level *Source:* <http://www.iala-aism.org/wiki/dictionary/index.php?oldid=5793> *Contributors:* Oferiks

Watt-hour meter *Source:* <http://www.iala-aism.org/wiki/dictionary/index.php?oldid=5119> *Contributors:* Oferiks

Wave *Source:* <http://www.iala-aism.org/wiki/dictionary/index.php?oldid=1400> *Contributors:* Oferiks

Wave-actuated generator *Source:* <http://www.iala-aism.org/wiki/dictionary/index.php?oldid=4611> *Contributors:* Oferiks

Wave-train *Source:* <http://www.iala-aism.org/wiki/dictionary/index.php?oldid=1184> *Contributors:* Oferiks

Waveguide *Source:* <http://www.iala-aism.org/wiki/dictionary/index.php?oldid=2953> *Contributors:* Oferiks

Wavelength *Source:* <http://www.iala-aism.org/wiki/dictionary/index.php?oldid=1164> *Contributors:* Oferiks

Wavelength (2) *Source:* <http://www.iala-aism.org/wiki/dictionary/index.php?oldid=2745> *Contributors:* Oferiks

Wave (2) *Source:* <http://www.iala-aism.org/wiki/dictionary/index.php?oldid=5751> *Contributors:* Oferiks

Wave antenna *Source:* <http://www.iala-aism.org/wiki/dictionary/index.php?oldid=2939> *Contributors:* Oferiks

Wave energy *Source:* <http://www.iala-aism.org/wiki/dictionary/index.php?oldid=4609> *Contributors:* Oferiks

Wave front *Source:* <http://www.iala-aism.org/wiki/dictionary/index.php?oldid=1170> *Contributors:* Oferiks

Wave height *Source:* <http://www.iala-aism.org/wiki/dictionary/index.php?oldid=5779> *Contributors:* Oferiks

Wave interference error *Source:* <http://www.iala-aism.org/wiki/dictionary/index.php?oldid=3315> *Contributors:* Oferiks

Wave load *Source:* <http://www.iala-aism.org/wiki/dictionary/index.php?oldid=5913> *Contributors:* Oferiks

Wave number *Source:* <http://www.iala-aism.org/wiki/dictionary/index.php?oldid=1166> *Contributors:* Oferiks

Wave reflection *Source:* <http://www.iala-aism.org/wiki/dictionary/index.php?oldid=5785> *Contributors:* Oferiks

Wave surface *Source:* <http://www.iala-aism.org/wiki/dictionary/index.php?oldid=1176> *Contributors:* Oferiks

Wave tilt *Source:* <http://www.iala-aism.org/wiki/dictionary/index.php?oldid=3091> *Contributors:* Oferiks

Wear-out-failure period *Source:* <http://www.iala-aism.org/wiki/dictionary/index.php?oldid=6276> *Contributors:* Oferiks

Weather-protected enclosure (or machine) *Source:* <http://www.iala-aism.org/wiki/dictionary/index.php?oldid=5149> *Contributors:* Oferiks

Web (of a girder) *Source:* <http://www.iala-aism.org/wiki/dictionary/index.php?oldid=5347> *Contributors:* Oferiks

Weight tube *Source:* <http://www.iala-aism.org/wiki/dictionary/index.php?oldid=5509> *Contributors:* Oferiks

Well-strobe marker *Source:* <http://www.iala-aism.org/wiki/dictionary/index.php?oldid=3489> *Contributors:* Oferiks

Wet Dock *Source:* <http://www.iala-aism.org/wiki/dictionary/index.php?oldid=1374> *Contributors:* Oferiks

Whip *Source:* <http://www.iala-aism.org/wiki/dictionary/index.php?oldid=849> *Contributors:* Oferiks

Whip antenna *Source:* <http://www.iala-aism.org/wiki/dictionary/index.php?oldid=2935> *Contributors:* Oferiks

Whistle *Source:* <http://www.iala-aism.org/wiki/dictionary/index.php?oldid=2709> *Contributors:* Oferiks

Whistle buoy *Source:* <http://www.iala-aism.org/wiki/dictionary/index.php?oldid=2711> *Contributors:* Oferiks

Whistle Buoy (2) *Source:* <http://www.iala-aism.org/wiki/dictionary/index.php?oldid=7165> *Contributors:* Oferiks

White *Source:* <http://www.iala-aism.org/wiki/dictionary/index.php?oldid=6623> *Contributors:* Oferiks

Wick *Source:* <http://www.iala-aism.org/wiki/dictionary/index.php?oldid=6757> *Contributors:* Oferiks

Wide aperture direction finder *Source:* <http://www.iala-aism.org/wiki/dictionary/index.php?oldid=3215> *Contributors:* Oferiks

Wide aperture Doppler direction finder *Source:* <http://www.iala-aism.org/wiki/dictionary/index.php?oldid=3217> *Contributors:* Oferiks

Winch *Source:* <http://www.iala-aism.org/wiki/dictionary/index.php?oldid=6209> *Contributors:* Oferiks

Wind-power generator *Source:* <http://www.iala-aism.org/wiki/dictionary/index.php?oldid=4543> *Contributors:* Oferiks

Wind-vane *Source:* <http://www.iala-aism.org/wiki/dictionary/index.php?oldid=5485> *Contributors:* Oferiks

Windlass *Source:* <http://www.iala-aism.org/wiki/dictionary/index.php?oldid=871> *Contributors:* Oferiks

Wind bracing *Source:* <http://www.iala-aism.org/wiki/dictionary/index.php?oldid=5241> *Contributors:* Oferiks

Wind energy *Source:* <http://www.iala-aism.org/wiki/dictionary/index.php?oldid=4539> *Contributors:* Oferiks

Wind energy conversion system *Source:* <http://www.iala-aism.org/wiki/dictionary/index.php?oldid=4541> *Contributors:* Oferiks

Wind load *Source:* <http://www.iala-aism.org/wiki/dictionary/index.php?oldid=5903> *Contributors:* Oferiks

Wind shear *Source:* <http://www.iala-aism.org/wiki/dictionary/index.php?oldid=4553> *Contributors:* Oferiks

Wind speed duration curve *Source:* <http://www.iala-aism.org/wiki/dictionary/index.php?oldid=4551> *Contributors:* Oferiks

Winter buoy *Source:* <http://www.iala-aism.org/wiki/dictionary/index.php?oldid=935> *Contributors:* Oferiks

Winter Buoy (U.S.A.) *Source:* <http://www.iala-aism.org/wiki/dictionary/index.php?oldid=7169> *Contributors:* Oferiks

Winter Light (U.S.A.) *Source:* <http://www.iala-aism.org/wiki/dictionary/index.php?oldid=7087> *Contributors:* Oferiks

Wire rope *Source:* <http://www.iala-aism.org/wiki/dictionary/index.php?oldid=831> *Contributors:* Oferiks

Withdrawal *Source:* <http://www.iala-aism.org/wiki/dictionary/index.php?oldid=1098> *Contributors:* Oferiks

Workability *Source:* <http://www.iala-aism.org/wiki/dictionary/index.php?oldid=6065> *Contributors:* Oferiks

Work barge *Source:* <http://www.iala-aism.org/wiki/dictionary/index.php?oldid=789> *Contributors:* Oferiks

World-Wide Radio Navigation System *Source:* <http://www.iala-aism.org/wiki/dictionary/index.php?oldid=7731> *Contributors:* Oferiks

World geodetic system (WGS) *Source:* <http://www.iala-aism.org/wiki/dictionary/index.php?oldid=7729> *Contributors:* Oferiks

Worst case *Source:* <http://www.iala-aism.org/wiki/dictionary/index.php?oldid=3813> *Contributors:* Oferiks

Wreck *Source:* <http://www.iala-aism.org/wiki/dictionary/index.php?oldid=1338> *Contributors:* Oferiks

Wreck Mark (or Buoy) *Source:* <http://www.iala-aism.org/wiki/dictionary/index.php?oldid=7131> *Contributors:* Oferiks

Wrought iron *Source:* <http://www.iala-aism.org/wiki/dictionary/index.php?oldid=5515> *Contributors:* Oferiks

X-ray test *Source:* <http://www.iala-aism.org/wiki/dictionary/index.php?oldid=6257> *Contributors:* Oferiks

Yagi antenna *Source:* <http://www.iala-aism.org/wiki/dictionary/index.php?oldid=2947> *Contributors:* Oferiks

Yaw *Source:* <http://www.iala-aism.org/wiki/dictionary/index.php?oldid=4591> *Contributors:* Oferiks

Zenith *Source:* <http://www.iala-aism.org/wiki/dictionary/index.php?oldid=1304> *Contributors:* Oferiks

Zinc *Source:* <http://www.iala-aism.org/wiki/dictionary/index.php?oldid=5529> *Contributors:* Oferiks

Zinc chromate primer *Source:* <http://www.iala-aism.org/wiki/dictionary/index.php?oldid=5691> *Contributors:* Oferiks

Image Sources, Licenses and Contributors

Image:Ch2_Fig65.jpg *Source:* http://www.iala-aism.org/wiki/dictionary/index.php?title=File:Ch2_Fig65.jpg *License:* unknown *Contributors:* Oferiks

Image:Ch2_Fig66.jpg *Source:* http://www.iala-aism.org/wiki/dictionary/index.php?title=File:Ch2_Fig66.jpg *License:* unknown *Contributors:* Oferiks

Image:Ch5_Fig3.jpg *Source:* http://www.iala-aism.org/wiki/dictionary/index.php?title=File:Ch5_Fig3.jpg *License:* unknown *Contributors:* Oferiks

Image:Ch2_Fig55.jpg *Source:* http://www.iala-aism.org/wiki/dictionary/index.php?title=File:Ch2_Fig55.jpg *License:* unknown *Contributors:* Oferiks

Image:Ch2_Fig20.jpg *Source:* http://www.iala-aism.org/wiki/dictionary/index.php?title=File:Ch2_Fig20.jpg *License:* unknown *Contributors:* Oferiks

Image:Ch5_Fig1.jpg *Source:* http://www.iala-aism.org/wiki/dictionary/index.php?title=File:Ch5_Fig1.jpg *License:* unknown *Contributors:* Oferiks

Image:Ch2_Fig57.jpg *Source:* http://www.iala-aism.org/wiki/dictionary/index.php?title=File:Ch2_Fig57.jpg *License:* unknown *Contributors:* Oferiks

Image:Ch2_Fig21.jpg *Source:* http://www.iala-aism.org/wiki/dictionary/index.php?title=File:Ch2_Fig21.jpg *License:* unknown *Contributors:* Oferiks

Image:Ch2_Fig54.jpg *Source:* http://www.iala-aism.org/wiki/dictionary/index.php?title=File:Ch2_Fig54.jpg *License:* unknown *Contributors:* Oferiks